

GLAP!i

THE REVOLUTION
OF INDOOR
FLOORING AND
COVERINGS

**INFRANGERE GLI SCHEMI.
NUOVAMENTE.**
BREAKING THE MOULD.
AGAIN.



DÉCO ALL AROUND COVERINGS

Déco da anni continua a spostare i confini del mercato dei rivestimenti, modificandone i trend di consumo. Investendo ogni giorno nello sviluppo di nuove tecnologie per continuare a proporre soluzioni e materiali innovativi, a più riprese Déco è stata in grado di creare nuovi bisogni, ridefinendo il concetto stesso di contemporary living.

Déco has continued to shift the boundaries of the coverings market for years, changing consumer trends. By investing every day in the development of new technologies to continue offering materials and innovative solutions, time and again Déco has been able to create new needs, redefining the very concept of contemporary living.

CONTENTS

06. CLAP! - LA LINEA / THE LINE

- 10. PLUS DELLA LINEA / THE PLUSES OF THE LINE
- 12. FLOOR AND WALL

14. CLAP! REAL

- 20. LA COLLEZIONE / THE COLLECTION
- 26. STRUTTURA E SOLUZIONI DI POSA
STRUCTURE AND INSTALLATION SOLUTIONS

28. CLAP! 3D

- 38. FORMATI E SOLUZIONI DI POSA
SIZES AND INSTALLATION SOLUTIONS
- 40. LA COLLEZIONE / THE COLLECTION
- 58. STRUTTURA / STRUCTURE

60. CLAP! GO

- 62. LA COLLEZIONE / THE COLLECTION
- 66. CLAP GO! BOARD
- 78. CLAP GO! TILES

90. CLAP! WALL

- 92. LA COLLEZIONE / THE COLLECTION
- 99. CLAP WALL! PANELS
- 106. CLAP WALL! TILES
- 112. CLAP WALL! BOARD

118. ACCESSORI / ACCESSORIES

124. AREA TECNICA / TECHNICAL AREA



CLAP!

DESIGN TO IMPRESS

Clap! by Déco è la collezione di rivestimenti per interni progettata per stupire in ogni ambiente. Grazie a prestazioni superiori a tutti i pavimenti tradizionali e ad una ineguagliabile resa estetica, Clap! è capace di donare fascino e personalità contraddistinta a qualsiasi contesto indoor.

Clap! by Déco is the floor and covering collection for interiors design to amaze in every environment. Thanks to the superior performance compared to traditional flooring and to the unparalleled aesthetic performance, Clap! is able to give charm and distinctive characteristics to any indoor context.





QUANDO L'ARTE INCONTRA L'INDOOR LIVING WHEN ART MEETS INDOOR LIVING

Tre collezioni d'avanguardia, un unico cuore tecnologico. Accomunate da un'anima in pietra e polimeri, le tre collezioni Clap!Real, Clap!3D e Clap!GO rappresentano la massima espressione della ricerca tecnologica, estetica e materica nel settore dei rivestimenti indoor.

Three innovative collections, a single technological heart. Brought together by a stone and polymer soul, the three Clap!Real, Clap!3D and Clap!GO collections represent the maximum expression of technological, aesthetic and material research in the industry of indoor coverings.



CLAP! IS UNIQUE

- **FACILE DA PULIRE**
EASY TO CLEAN

Grazie allo strato di protezione superficiale Clap! non teme liquidi e sostanze oleose ed è facilissimo da pulire con un semplice detergente neutro. Inoltre, la quasi totale assenza di fughe impedisce il depositarsi di sporco e batteri tra un profilo e l'altro.

Thanks to the superficial layer of protection, Clap! is not afraid of liquids and oily substances and is very easy to clean with just a mild detergent. Additionally, the almost total absence of joint lines prevents dirt and bacteria build-up between the boards.

- **RESISTENTE AD ACQUA E UMIDITÀ**
RESISTANT TO WATER AND HUMIDITY

La componente in pietra presente nel mix prodotto interno rende Clap! resistente all'umidità e quindi adatto anche per la posa in bagni e cucine.

The stone component in the product mix makes Clap! resistant to humidity and therefore also suitable for installation in bathrooms and kitchens.

- **ANCHE SU RISCALDAMENTO RADIANTE**
ALSO FOR RADIANT HEATING

Registrandolo un basso indice di resistenza termica, i rivestimenti della linea Clap! sono adatti ad una posa su sistemi radianti tradizionali di riscaldamento/raffrescamento.

Having registered also a low index of thermal resistance, the flooring and coverings from the Clap! line are suitable to be installed over traditional radiant systems for heating/cooling.

- **SILENZIOSO AL CALPESTIO**
SILENT TREAD

I fastidiosi rumori di calpestio vengono minimizzati dal tappetino integrato migliorando notevolmente il comfort acustico degli ambienti.

Annoying noises from foot traffic are minimised by the integrated underlay significantly improving acoustic comfort of environments.

- **POSA IMMEDIATA E SUBITO CALPESTABILE**
QUICK INSTALLATION AND READY FOR FOOT TRAFFIC

Grazie al tappetino integrato Clap! garantisce un'installazione rapida e immediata, senza previa installazione di un sottopavimento. La posa ad incastro permette inoltre di avere un pavimento subito calpestabile.

Thanks to the integrated underlay Clap! guarantees rapid and immediate installation, without previously installing an underfloor. The interlocking installation also makes the flooring immediately ready for foot traffic.

- **POSA IN CASE AMMOBILIATE**
INSTALLATION IN FURNISHED HOMES

Clap! può essere installato anche in case ammobiliate e senza dover demolire il pavimento esistente, spostando semplicemente i mobili al procedere della posa.

Clap! can also be installed in furnished homes and without having to demolish existing flooring, simply moving the furniture and proceeding with the installation.





SOLUZIONI DI RIVESTIMENTO PER PAVIMENTI E PARETI COVERING SOLUTIONS FOR FLOORS AND WALLS

La famiglia Clap! si declina in una vasta gamma di rivestimenti, ideali sia per pavimenti che per pareti. Questi prodotti si distinguono per la loro versatilità e design, offrendo soluzioni estetiche e funzionali per ogni ambiente. Grazie alla varietà di finiture e formati disponibili, Clap! permette di creare spazi unici e personalizzati, soddisfacendo le esigenze di chi cerca stile e praticità in ogni dettaglio.

The Clap! family includes a wide range of coverings, ideal for both floors and walls. These products stand out for their versatility and design, offering aesthetic and functional solutions for every space. With a variety of finishes and colors available, Clap! allows for the creation of unique and personalized environments, meeting the needs of those seeking style and practicality in every detail.



CLAP! REAL

IL LEGNO NATURALE NON È MAI STATO COSÌ TECNOLOGICO

Clap!Real è il nuovo pavimento in legno naturale con un cuore in pietra e polimeri. Una novità assoluta ideata per permettere di camminare e vivere su un pavimento in legno naturale godendo, al contempo, di tutti i vantaggi di un materiale altamente performante.

NATURAL WOOD HAS NEVER BEEN SO TECHNOLOGICAL

Clap!Real is the new wood flooring made of natural wood with a stone and polymer core. A totally innovative idea to allow for walking and living on a natural wood floor enjoying, at the same time, all the advantages of a high-performance material.





**LEGNO NATURALE.
AD OGNI PASSO.
NATURAL WOOD.
AT EVERY STEP.**

Con uno strato calpestabile in legno naturale, Clap!Real è il rivoluzionario pavimento per interni in rovere potenziato. La vernice protettiva e l'evoluto compound interno concorrono nel rendere Clap!Real il rivestimento in legno naturale più performante di sempre in termini di stabilità, resistenza all'umidità, facilità di manutenzione e semplicità di posa.

With a layer for foot traffic in natural wood, Clap!Real is the revolutionary flooring for interiors in enhanced oak. The waterproof protective shield and advanced internal compound contribute to making Clap!Real the most high-performance natural wood covering ever in terms of stability, resistance to humidity, easy maintenance and installation.





SUBITO. OVUNQUE.
IMMEDIATELY. EVERYWHERE.

Nessun tempo di asciugatura: Clap!Real è il nuovo pavimento in legno calpestabile subito dopo la posa. Sfruttando l'innovativo sistema a incastro 5G, le doghe Clap!Real si installano saldamente e con rapidità anche su pavimenti esistenti e senza necessitare di collanti.

No drying time: Clap!Real is the new wood flooring ready for foot traffic immediately after installation. Using the innovative 5G interlocking system, Clap!Real boards are firmly and quickly installed also over existing floors and without requiring glue.

CLAP! REAL COLLECTION

LE FINITURE / THE FINISHES

ITA 
visualizza Clap!
a casa tua

ENG 
visualize Clap!
in your space

MASO



IURTA

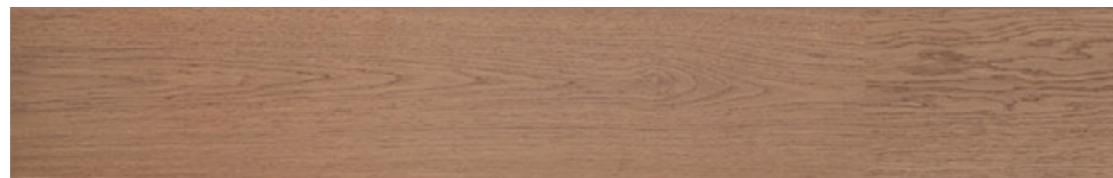

LOG



ROBU



Clap!Real è una collezione realizzata con uno strato di finitura in legno di rovere 100% naturale. Tutte le immagini sono da intendersi puramente indicative in quanto, essendo rifinite con essenze naturali, ogni dogia è unica e diversa dalle altre. Per lo stesso motivo, diversi lotti produttivi possono includere normali stonalizzazioni oltre che differenze di intensità di nodi e venature.

Clap!Real is a collection created with a layer of 100% natural oak surface. All the images are purely indicative since, as they are finished with natural elements, each board is unique and different from the others. For the same reason, different production lots can include normal shade variation in addition to differences in the intensity of knots and grains.

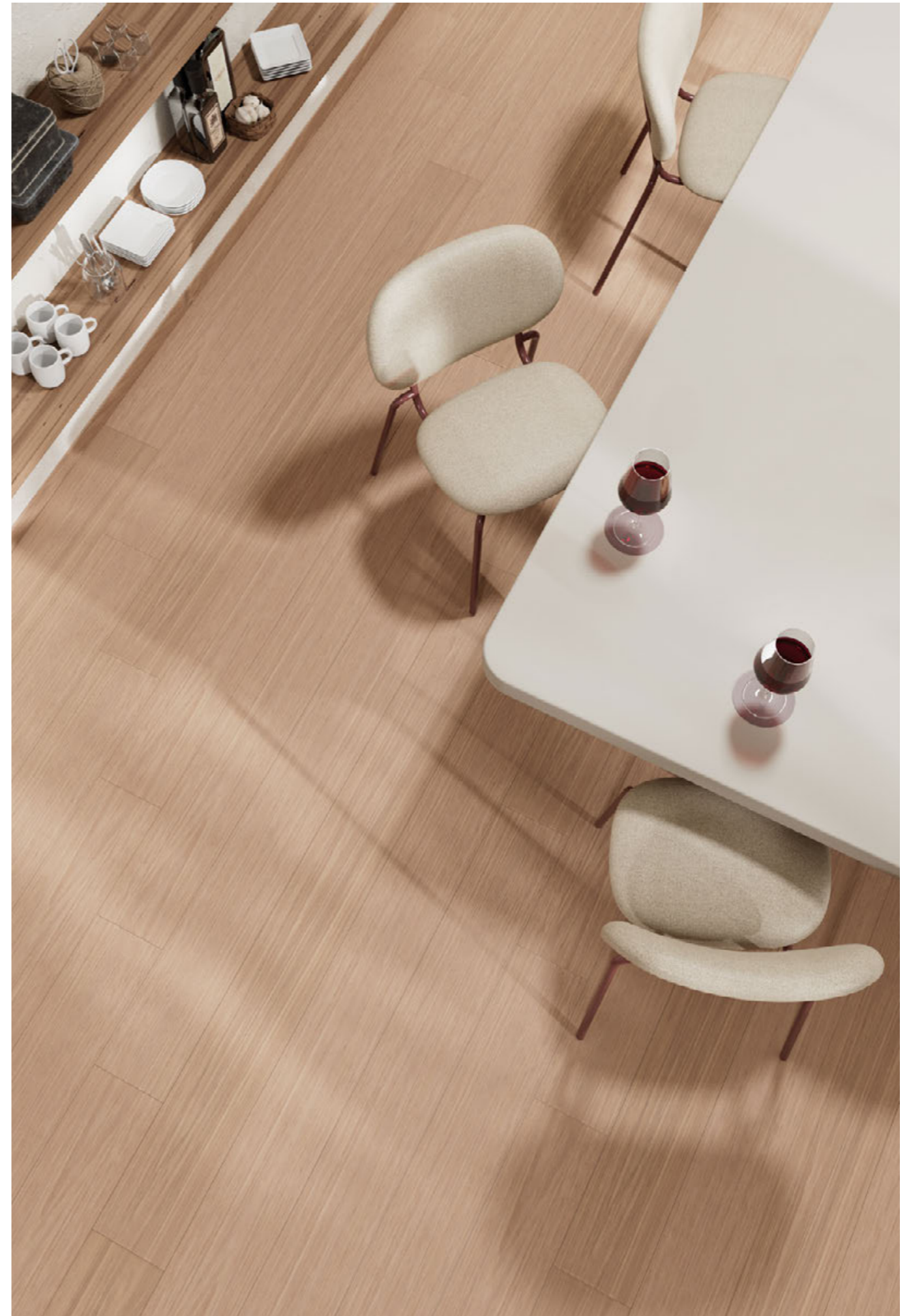



MASO

Con fiammate che possono variare di intensità creando un effetto visivo dinamico e interessante, la finitura Maso ricorda le colorazioni calde e avvolgenti del legno di castagno.

With flaming of varied intensity that creates a dynamic and interesting visual effect, the Maso finish evokes the warm and cosy colours of chestnut wood.

DOGA CLASSICA / CLASSIC BOARD

8 x 190 x 1900 mm



IURTA

Iurta è una finitura in rovere color nocciola che offre un'elegante combinazione di tonalità naturali e calde, perfetta per donare agli ambienti un aspetto accogliente e raffinato.

Iurta is a finish in hazelnut-coloured oak that offers an elegant combination of natural and warm tones, perfect for creating a refined and cosy ambience.

DOGA CLASSICA / CLASSIC BOARD

8 x 190 x 1900 mm



Il Maso è una proprietà fondiaria tipica del Tirolo composta da varie tipologie di edifici, come fienili, stalle e case patronali, tradizionalmente realizzati in legno e progettati per adattarsi al clima alpino.

A Maso is a typical landed property found in the Tyrol region, composed of various types of building, such as hay barns, stables and accommodation for the owners, traditionally made in wood and designed to adapt to the Alpine climate.

DÉCO INSPIRATION
MASO / ITALY



Una Yurta è una struttura abitativa tradizionale utilizzata nelle regioni dell'Asia centrale, in particolare in Mongolia. Si tratta di una tenda circolare e portatile, realizzata in legno e progettata per essere facilmente smontabile e trasportabile, adattandosi al tradizionale stile di vita nomade.

A yurt is a traditional habitation used in central Asia, in particular in Mongolia. It consists of a circular portable tent made in wood and designed to be easily dismantled and transported, adapting to the traditional nomadic lifestyle.

DÉCO INSPIRATION
YURTA / MONGOLIA



LOG

Proponendo la grana distintiva del legno di quercia, con le sue striature e nodi, la finitura Log aggiunge profondità visiva e carattere al pavimento.

Offering the distinctive grain of oak wood, with its lines and knots, the Log finish adds visual depth and character to floors.



DOGA CLASSICA / CLASSIC BOARD

8 x 190 x 1900 mm



ROBU

Con una tonalità che oscilla tra l'ambra e il rosa chiaro, la finitura Robu crea un effetto visivo unico e affascinante, conferendo agli ambienti un'atmosfera calda e delicata.

With tones that range from amber to light pink, the Robu finish creates a unique and charming visual effect, lending a warm and delicate atmosphere to rooms.

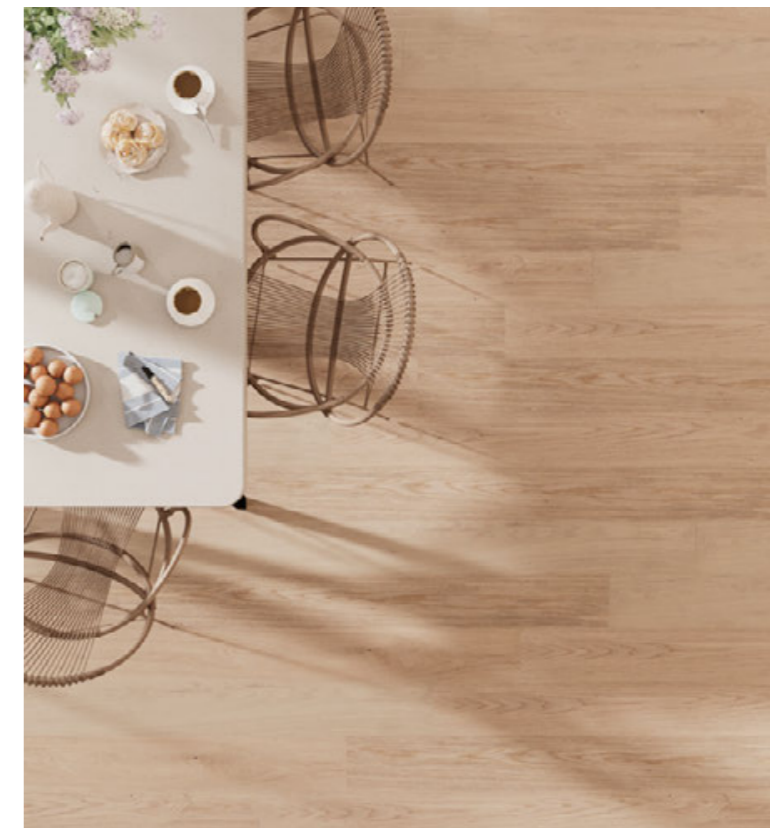

DOGA CLASSICA / CLASSIC BOARD

8 x 190 x 1900 mm



Una log cabin, o "casa di tronchi", è una tipologia di abitazione costruita utilizzando tronchi di legno sovrapposti o incrociati per formare le pareti della struttura. Questo tipo di edificio è spesso associato alla tradizione costruttiva delle più antiche città della Scandinavia Settentrionale.

A log cabin is a type of habitation constructed with the use of logs placed on top of each other or interlaced to form walls. This type of construction is often associated with traditional building methods used by the older towns in Northeast Scandinavia.

DÉCO INSPIRATION
LOG CABIN / SCANDINAVIA



Una "rorbu" è un tipo di abitazione tradizionale norvegese realizzata tipicamente in legno e utilizzata nelle regioni costiere della Norvegia settentrionale e delle isole Lofoten come alloggio per i pescatori durante la stagione della pesca.

A "rorbu" is a traditional form of Norwegian habitation made typically in wood and used in the coastal regions of Northern Norway and the Lofoten islands as accommodation for fishermen during the fishing season.

DÉCO INSPIRATION
ROBU / NORWAY

CLAP! REAL

STRUTTURA E SOLUZIONI DI POSA / STRUCTURE AND INSTALLATION SOLUTIONS

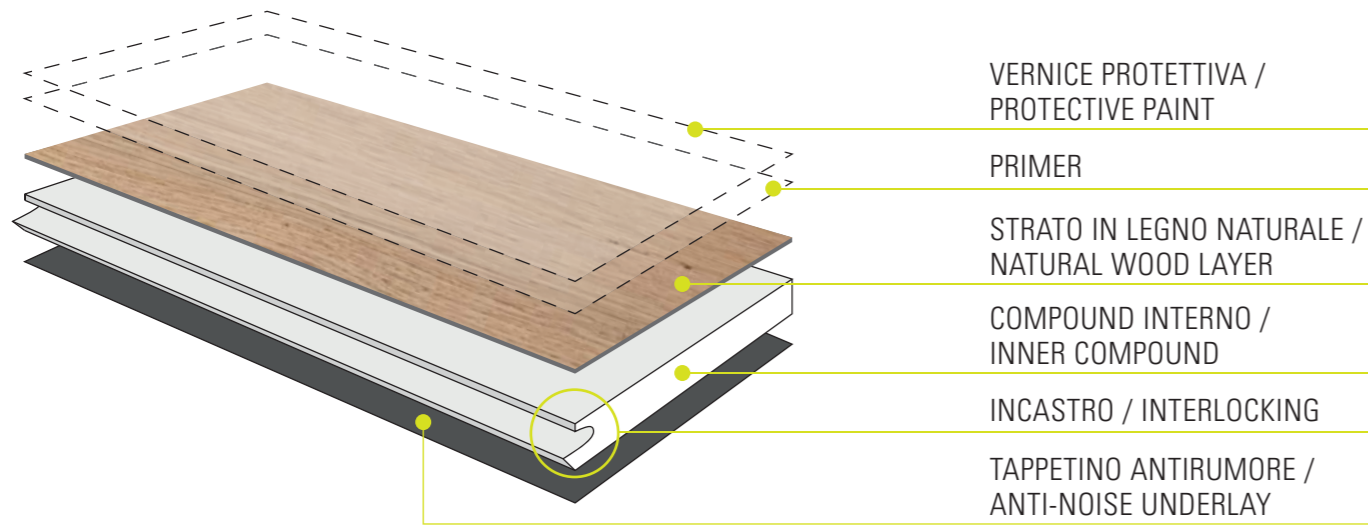

SISTEMA DI POSA A INCASTRO / INTERLOCKING INSTALLATION SYSTEM

L'innovativo sistema a incastro 5G brevettato permette una posa rapida e subito calpestabile anche su pavimenti esistenti e in case ammobiliate, senza l'utilizzo di collanti e senza necessitare di tempi di asciugatura.

The innovative 5G interlocking system allows for a quick installation immediately ready for foot traffic, also over existing flooring and in furnished homes, without requiring glue and without drying times.

DOGA CLASSICA / CLASSIC BOARD

8 x 190 x 1900 mm

Schema classico con sfalsatura
di min 30cm.
Classic layout with 30cm staggering.

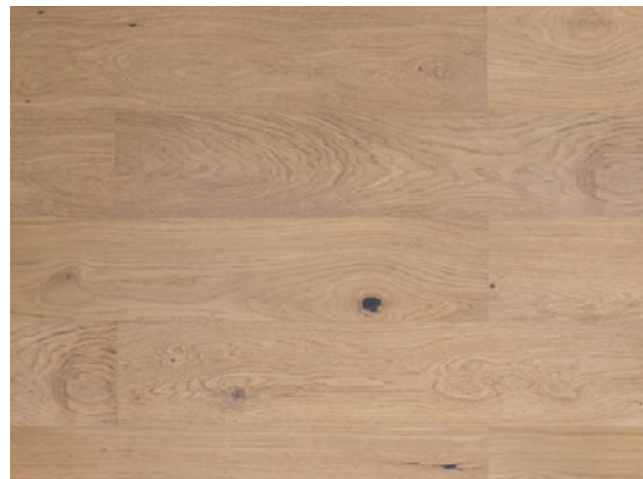
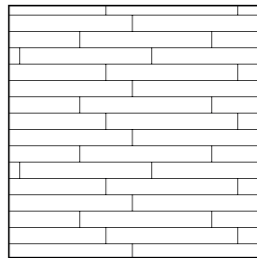

CLAP!3D

LA NUOVA DIMENSIONE DEL REALISMO

Clap!3D è la collezione di pavimenti per interni dal realismo senza precedenti.

Ogni venatura e dettaglio del legno è riprodotto ad arte per restituire al tatto e alla vista tutta la matericità del legno naturale, mentre la stonalizzazione delle doghe, diverse tra loro per trama e sfumatura, consente di ricreare la caratteristica eterogeneità cromatica.

THE NEW DIMENSION OF REALISM

Clap!3D is the collection of flooring for interiors with unprecedented realism. Each grain and detail of the wood is artfully reproduced to give the touch and sight all the texture of natural wood, while the shade variation of the boards, different among themselves for the pattern and hues, allows for recreating the characteristic chromatic diversity.

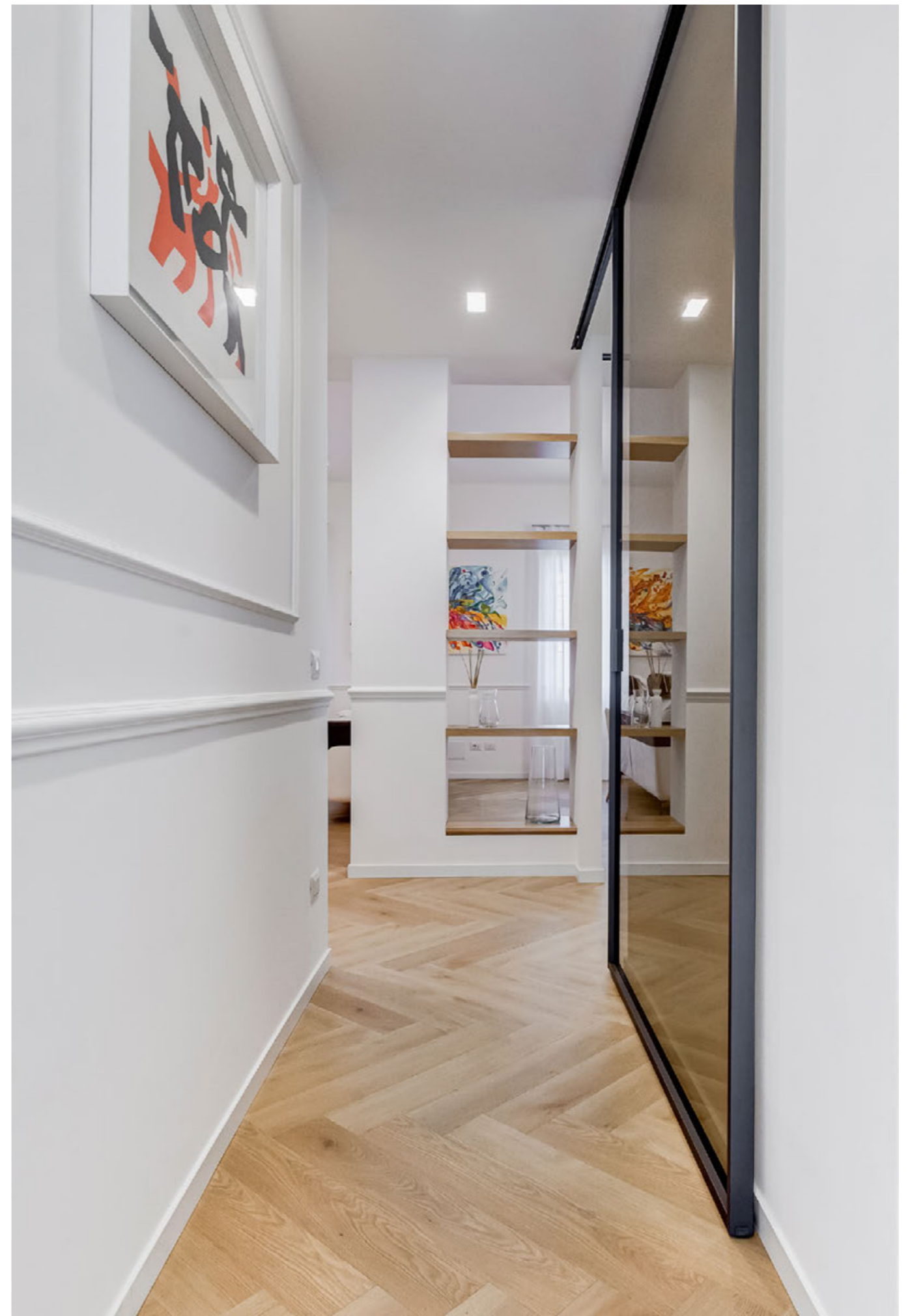



TOCCARE PER CREDERE **TOUCHING IS BELIEVING**

Una scommessa da vincere a occhi chiusi.
Basta toccare con mano una dogia di Clap!3D per
sentire scorrere sotto le dita i rilievi e le venature
del legno realizzati con stupefacente accuratezza
e precisione.

A bet to win eyes closed. It is enough to just touch
a Clap!3D board to feel the reliefs and grains of the
wood made with surprising accuracy and precision.



**L'ELEGANZA DELLA
SPINA UNGHERESE**
THE ELEGANCE OF THE
HERRINGBONE PATTERN

La collezione si arricchisce con l'introduzione del nuovo formato di pavimenti a spina di pesce ungherese, un'elegante variante dello schema classico. Caratterizzata da listelli tagliati con angoli di 60 gradi, questa posa crea un motivo sofisticato, capace di donare profondità e classe agli ambienti.

The collection is enhanced with the introduction of the new Hungarian herringbone flooring format, an elegant variant of the classic pattern. Characterized by strips cut at 60-degree angles, this installation creates a sophisticated design, capable of adding depth and movement to any space.





**IL FASCINO SENZA TEMPO
DELLA POSA A SPINA ITALIANA
THE TIMELESS APPEAL OF
ITALIAN HERRINGBONE LAYING**

Perfetta per assecondare ogni ambiente, la posa a spina di pesce nella sua variante "italiana", conferisce un senso di dinamismo alla pavimentazione, rendendola visivamente più ampia e ricercata.

Perfect for pandering to any environment, herringbone laying in its "Italian" variant lends a sense of dynamism to flooring, making it visually wider and more refined.





POSA CLASSICA E MULTIFORMAT. CLASSIC INSTALLATION AND MULTIFORMAT.

Dove i formati Doga Max e Doga S sono perfetti per chi predilige soluzioni dal gusto più tradizionale, la posa Multiformat è invece la scelta ideale per chi ricerca dettagli di design dal carattere contemporaneo.

Where the Doga Max and Doga S formats are perfect for those who prefer more traditional solutions, the Multiformat installation is the ideal choice for those seeking design details with a contemporary character.

CLAP!3D

FORMATI, SOLUZIONI DI POSA / SIZES, INSTALLATION SOLUTIONS

DOGA MAX / MAX BOARD DOGA S / S BOARD

6 x 228 x 1800 mm
5 x 181 x 1220 mm

Schema classico con sfalsatura
di min 30cm.
Classic layout with 30cm staggering.

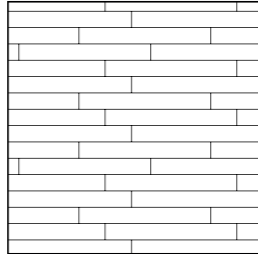

CLAP!3D

FORMATI, SOLUZIONI DI POSA / SIZES, INSTALLATION SOLUTIONS

DOGA SPINA ITALIANA / ITALIAN HERRINGBONE BOARD

5,5 x 127 x 762 mm

Doga a spina di pesce
variante "italiana".
Herringbone board with
"Italian" variation.

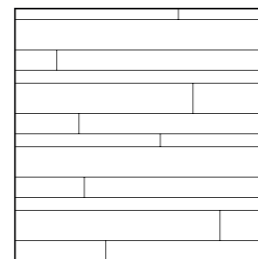
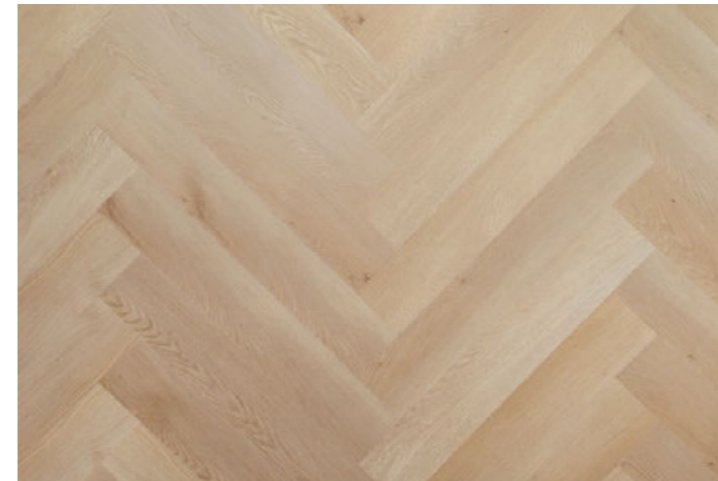
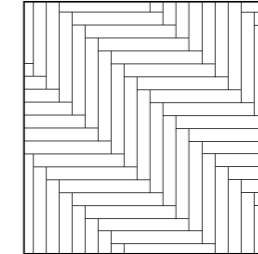

DOGHE MULTIFORMAT / MULTI-FORMAT BOARD

6 x 228/181/150 x 1800mm

Schema con sfalsatura
di min 30cm.
Layout with 30cm staggering.

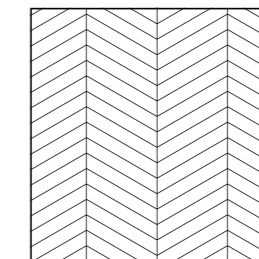

DOGA SPINA UNGHERESE/ HUNGARIAN HERRINGBONE BOARD

5,5 x 127 x 762 mm

Doga a spina di pesce
variante "Ungherese".
Herringbone board with
"Hungarian" variation.

NEW

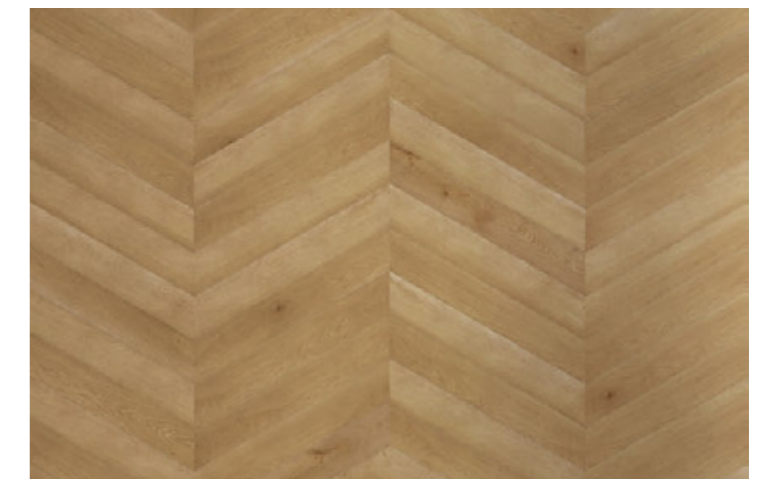

CLAP! 3D COLLECTION

FINITURE E FORMATI / FINISHES AND FORMATS

CLAP!3D DOGA MAX

6 x 228 x 1800 mm

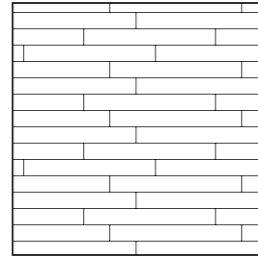
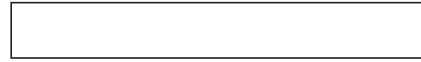

FINITURE / FINISHES

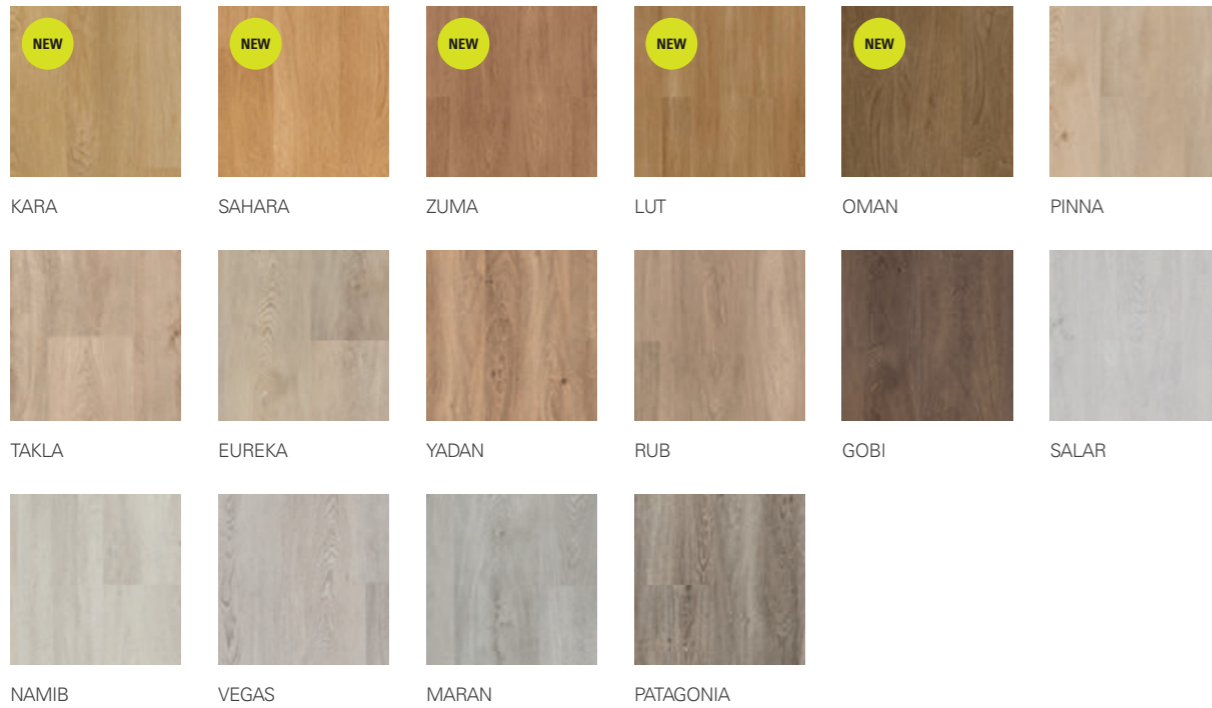

CLAP!3D DOGA S

5 x 181 x 1220 mm

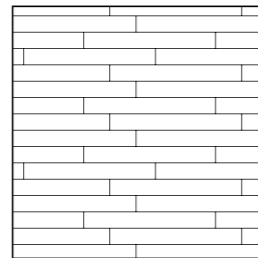

FINITURE / FINISHES



ITA
visualizza Clap!
a casa tua



ENG
visualize Clap!
in your space



CLAP!3D MULTIFORMAT

6 x 228 / 181 / 150 x 1800 mm

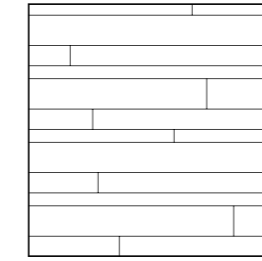
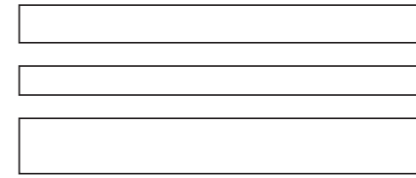

FINITURE / FINISHES



PINNA

CLAP!3D SPINA ITALIANA

5,5 x 127 x 762 mm

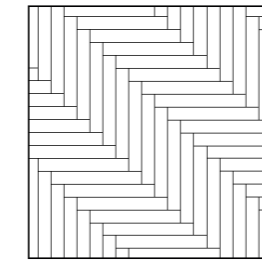
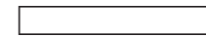

FINITURE / FINISHES



CLAP!3D SPINA UNGHERESE

5,5 x 127 x 762 mm

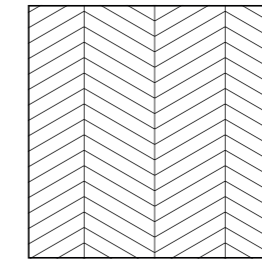
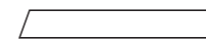

FINITURE / FINISHES





KARA

NEW

Un tono profondo e ricco, ispirato al deserto del Karakum, porta una sensazione di mistero e sofisticazione agli interni più ricercati.

A deep and rich tone, inspired by the Karakum Desert, brings a sense of mystery and sophistication to the most refined interiors.

DOGA MAX / MAX BOARD

6 x 228 x 1800 mm



SAHARA

NEW

Un caldo tono dorato che richiama le dune infinite del Sahara, perfetto per creare atmosfere luminose e accoglienti, con un tocco di esotica raffinatezza.

A warm golden tone that evokes the endless dunes of the Sahara, perfect for creating bright and welcoming atmospheres, with a touch of exotic sophistication.

DOGA MAX / MAX BOARD

6 x 228 x 1800 mm



Situato in Turkmenistan, il Karakum è un deserto scuro e roccioso, noto per le sue sabbie nere e la sua atmosfera misteriosa. È un paesaggio aspro e isolato, ma ricco di fascino e silenzi profondi.

Located in Turkmenistan, the Karakum is a dark, rocky desert known for its black sands and mysterious atmosphere. It is a harsh, isolated landscape, yet rich in charm and deep silences.

DÉCO INSPIRATION
KARAKUM DESERT / TURKMENISTAN



Il più grande deserto caldo del mondo, con vaste distese di dune dorate e cieli limpidi. Le sue temperature estreme e la luce accecante creano paesaggi mozzafiato, simbolo di maestosità e vastità infinita.

The largest hot desert in the world, with vast stretches of golden dunes and clear skies. Its extreme temperatures and dazzling light create breathtaking landscapes, symbolizing majesty and endless vastness.

DÉCO INSPIRATION
SAHARA DESERT / NORTH AFRICA

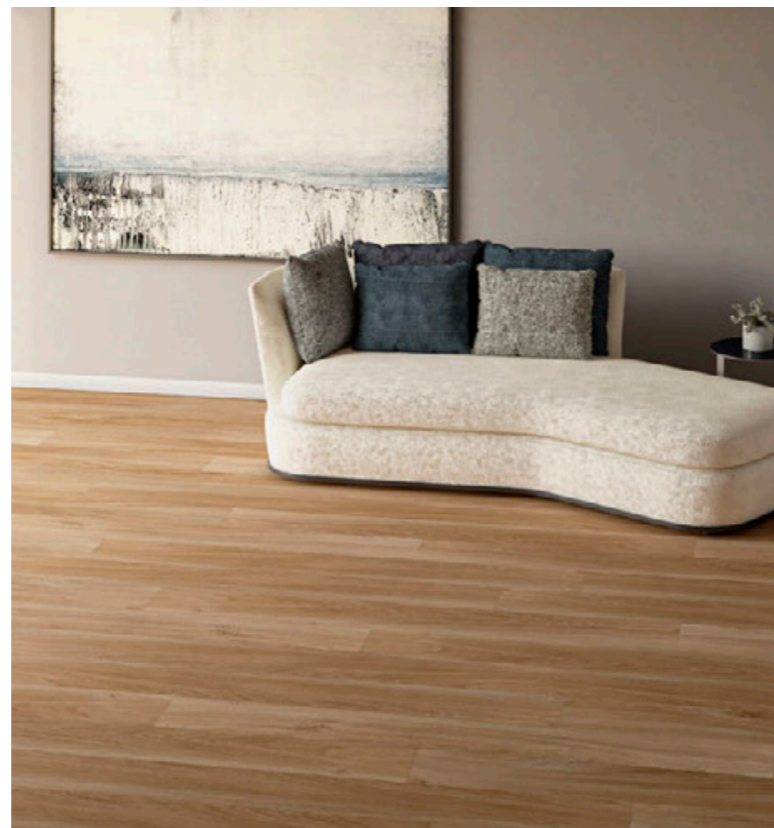

ZUMA

NEW

Un grigio sabbia chiaro, ispirato alle coste ventose di Zuma Beach, offre un'eleganza rilassata, ideale per ambienti moderni e minimalisti.

A light sand gray, inspired by the windy shores of Zuma Beach, offering relaxed elegance, ideal for modern and minimalist environments.

DOGA MAX / MAX BOARD

6 x 228 x 1800 mm



LUT

NEW

Un marrone intenso con sfumature ambrate, che evoca la forza e la maestosità del deserto del Lut, perfetto per spazi che vogliono trasmettere calore e personalità.

A deep brown with amber hues, evoking the strength and majesty of the Lut Desert, perfect for spaces that want to convey warmth and personality.

DOGA MAX / MAX BOARD

6 x 228 x 1800 mm



Situata sulla costa della California, Zuma Beach è famosa per le sue sabbie dorate e il mare cristallino. Caratterizzata da un clima mite e ventoso, evoca una sensazione di relax e libertà a pochi passi dall'oceano.

Located on the California coast, Zuma Beach is famous for its golden sands and crystal-clear sea. Known for its mild and windy climate, it evokes a feeling of relaxation and freedom just steps from the ocean.

DÉCO INSPIRATION
ZUMA BEACH / UNITED STATES



Uno dei luoghi più aridi e inhospitali del pianeta, il deserto del Lut in Iran è noto per le sue rocce scolpite dal vento e le superfici bruciate dal sole, con temperature che possono raggiungere livelli estremi, creando un paesaggio austero e potente.

One of the driest and most inhospitable places on Earth, the Lut Desert in Iran is known for its wind-sculpted rocks and sun-scorched surfaces, with temperatures that can reach extreme levels, creating a stark and powerful landscape.

DÉCO INSPIRATION
LUT DESERT / IRAN



OMAN

NEW

Con un caldo tono che ricorda il teak naturale, la finitura Oman dona agli interni un'eleganza senza tempo, evocando accoglienza e raffinatezza con venature autentiche.

With a warm tone reminiscent of natural teak, the Oman finish brings timeless elegance to interiors, evoking warmth and sophistication with authentic grain patterns.

DOGA MAX / MAX BOARD

6 x 228 x 1800 mm



PINNA

Le tonalità dorate del profilo Pinna risultano perfette per riscaldare gli spazi e renderli amabili e accoglienti.

The golden shades of the Pinna trim are perfect to warm spaces and make them pleasant and welcoming.

DOGA MAX / MAX BOARD

6 x 228 x 1800 mm



DOGA S / S BOARD

5 x 181 x 1220 mm



DOGA PER MULTIFORMAT / MULTI-FORMAT BOARD

6 x 228 / 181 / 150 x 1800 mm

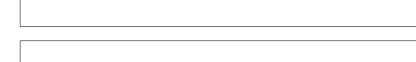

DOGA PER SPINA ITALIANA / ITALIAN HERRINGBONE BOARD

DOGA PER SPINA UNGHERESE / HUNGARIAN HERRINGBONE BOARD

5,5 x 127 x 762 mm



L'Oman, situato nella Penisola Arabica, è una terra di deserti dorati, montagne maestose e coste incontaminate, ricca di storia antica e ospitalità autentica.

Oman, located on the Arabian Peninsula, is a land of golden deserts, majestic mountains, and pristine coastlines, rich in ancient history and authentic hospitality.

DÉCO INSPIRATION
OMAN REGION / ARABIAN PENINSULA



Il Pinnacles Desert è un deserto australiano conosciuto per la presenza di formazioni calcaree simili ad altissime colonne e chiamate, appunto, "pinnacoli".

The Pinnacles Desert is an Australian desert known for its limestone formations similar to very tall columns and, therefore, called "pinnacles".

DÉCO INSPIRATION
PINNACLES DESERT / AUSTRALIA

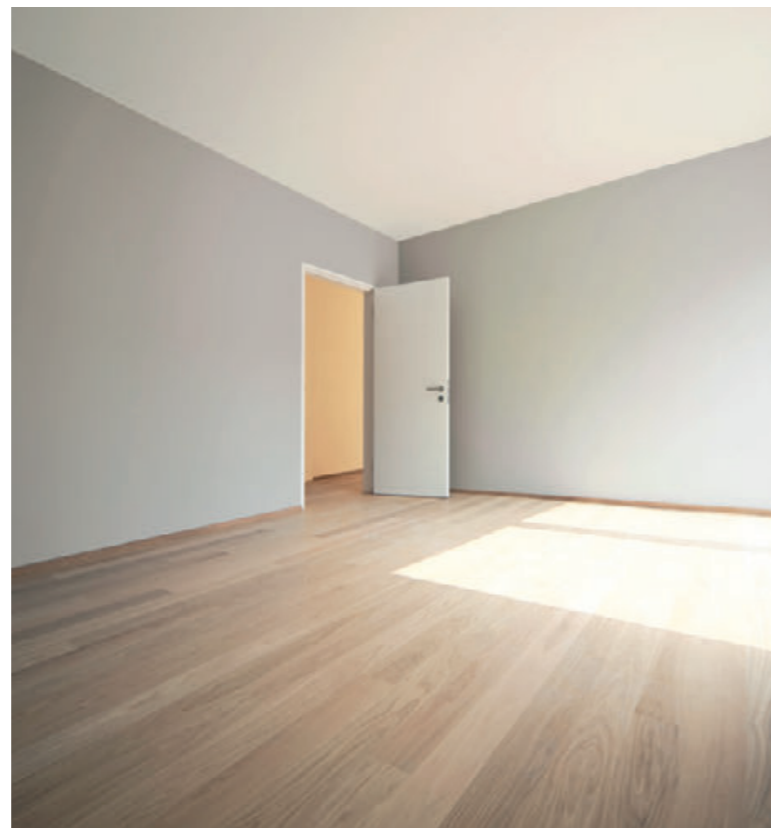

TAKLA

Un senso di tepore è reso dalle venature calde che evocano un senso di romantica intimità.

A sense of cosiness comes from the warm grains that evoke a sense of romantic intimacy.

DOGA MAX / MAX BOARD

6 x 228 x 1800 mm



DOGA S / S BOARD

5 x 181 x 1220 mm



DOGA PER SPINA ITALIANA / ITALIAN HERRINGBONE BOARD

5,5 x 127 x 762 mm



DOGA PER SPINA UNGHERESE / HUNGARIAN HERRINGBONE BOARD

5,5 x 127 x 762 mm



Forse il luogo più inospitale che possa essere immaginato: il deserto del Taklamakan è il punto del pianeta più lontano dal mare, collocato nel nord-est della Cina a confine con la Mongolia.

Perhaps the most unwelcoming place imaginable: the Taklamakan desert is the farthest point on the planet from the sea, located in north-east China on the border with Mongolia.

DÉCO INSPIRATION
TAKLAMAKAN DESERT / CHINA



EUREKA

Il color sabbia, con le sue sfumature cromatiche che vanno dal rosa al grigio, dona all'ambiente un'atmosfera esotica e raffinata.

The colour sand, with its chromatic hues that go from pink to grey, give the environment an exotic and sophisticated atmosphere.

DOGA MAX / MAX BOARD

6 x 228 x 1800 mm

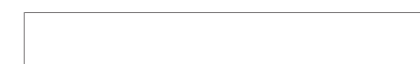

DOGA PER SPINA ITALIANA / ITALIAN HERRINGBONE BOARD

5,5 x 127 x 762 mm



DOGA PER SPINA UNGHERESE / HUNGARIAN HERRINGBONE BOARD

5,5 x 127 x 762 mm



Le Eureka Dunes sono le incredibili dune di sabbia della Eureka Valley note per il misterioso fenomeno detto "singing dunes", ovvero "dune cantanti": quando il terreno è completamente asciutto, sembra di riuscire a sentire un suono basso, simile alla nota di un organo, come emanato dalla sabbia stessa.

The Eureka Dunes are the incredible sand dunes of the Eureka Valley known for the mysterious phenomenon called "singing dunes": when the sand is completely dry, you can almost hear a low sound, similar to a note from an organ, as if made by the sand itself.

DÉCO INSPIRATION
EUREKA VALLEY / CALIFORNIA, USA



YADAN

Delle vorticosi striature creano un sorprendente senso di movimento dando vita a un'atmosfera dinamica e dal gusto tropicale.

Whirling streaks create a surprising sense of movement giving life to a dynamic atmosphere with a tropical flavour.

DOGA MAX / MAX BOARD

6 x 228 x 1800 mm



DOGA S / S BOARD

5 x 181 x 1220 mm



DOGA PER SPINA ITALIANA / ITALIAN HERRINGBONE BOARD

5,5 x 127 x 762 mm



DOGA PER SPINA UNGHERESE / HUNGARIAN HERRINGBONE BOARD

5,5 x 127 x 762 mm



L'area desertica del Parco Geologico Nazionale Yadan ospita delle particolari rocce plasmate dal vento e dagli agenti atmosferici. Queste sculture naturali, dette appunto yadan, sono le più grandi formazioni geologiche di questo tipo.

In the desert area of the Yadan National Geological Park, it is possible to find rocks shaped by the wind and atmospheric agents. These natural sculptures, called yadan, are the largest geological formations of this kind.

DÉCO INSPIRATION
YADAN NATIONAL PARK / CHINA



RUB

Una base calda arricchita da sfumature fredde rende queste doghe perfettamente in linea con i gusti di chi ricerca la modernità senza però rinunciare al calore accogliente tipico del legno.

A warm base enriched by cold hues makes these boards perfectly in line with the taste of those looking for modernity without giving up on the welcoming warmth typical of wood.

DOGA MAX / MAX BOARD

6 x 228 x 1800 mm



DOGA PER SPINA ITALIANA / ITALIAN HERRINGBONE BOARD

5,5 x 127 x 762 mm

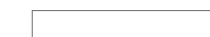

DOGA PER SPINA UNGHERESE / HUNGARIAN HERRINGBONE BOARD

5,5 x 127 x 762 mm

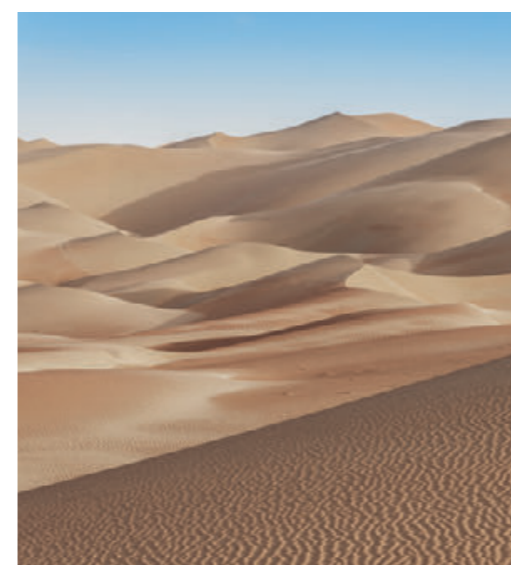

Conosciuto come "Il quarto vuoto", il Rub' al-Khali è il più grande deserto di sabbia al mondo dopo il Sahara, scrigno delle delicatissime e cristalline rose del deserto. Un'ampia distesa inesplorata di ghiaia e gesso di cui persino i beduini sfiorano solo i confini.

Known as the "the Empty Quarter", the Rub' al-Khali is the largest sand desert in the world after the Sahara, home to extremely delicate and crystalline desert roses. A wide unexplored stretch of gravel and chalk where even the Bedouin barely touch the borders.

DÉCO INSPIRATION
RUB' AL KHALI DESERT / ARABIAN PENINSULA



GOBI

Il colore scuro e profondo di queste doghe si rivela perfetto per creare un'atmosfera avvolgente e signorile.

The dark and deep colour of these boards is revealed perfectly to create a charming and refined atmosphere.

DOGA MAX / MAX BOARD

6 x 228 x 1800 mm



SALAR

Capaci di dare luce a qualsiasi ambiente, le tonalità chiare e fredde delle doghe riescono a trasmettere un forte senso di quiete e limpidezza.

Capable of giving light to any environment, the light and cool tones of the boards are able to transmit a strong sense of quiet and clearness.

DOGA MAX / MAX BOARD

6 x 228 x 1800 mm

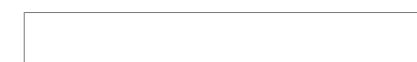

Il deserto del Gobi è una vasta distesa rocciosa dell'Asia Orientale. Un tempo ricco di acque e vegetazione, leggende raccontano che fu il passaggio degli imponenti eserciti condotti da Gengis Khan a trasformare questo territorio, un tempo florido, in un deserto roccioso.

The Gobi desert is a vast, rocky expanse of Western Asia. Once an area rich in water and vegetation, legend has it that the passage of the impressive armies led by Genghis Khan, led to the transformation of this territory, once flourishing, into a rocky desert.

DÉCO INSPIRATION
GOBI DESERT / MONGOLIA



Nascosto tra le montagne della Bolivia meridionale, il deserto del Salar si è formato in seguito alla lenta evaporazione di un lago salato rendendolo il luogo magico che è ora: una bianchissima distesa di terra in cui lo sguardo si perde.

Hidden between the mountains of southern Bolivia, the desert of the Salar was formed following the slow evaporation of a salted lake making it the magical place it is today: a very white never-ending stretch of land.

DÉCO INSPIRATION
SALAR DE UYUNI / BOLIVIA



NAMIB

Sfumature che oscillano tra l'avorio e il color sabbia, perfette per scaldare e alleggerire ambienti poco luminosi.

Hues that vary from ivory to the colour sand, perfect to warm and lighten environments that are not very bright.

DOGA MAX / MAX BOARD

6 x 228 x 1800 mm



DOGA PER SPINA ITALIANA / ITALIAN HERRINGBONE BOARD

5,5 x 127 x 762 mm



DOGA S / S BOARD

5 x 181 x 1220 mm



DOGA PER SPINA UNGHERESE / HUNGARIAN HERRINGBONE BOARD

5,5 x 127 x 762 mm



VEGAS

Una bellezza che si impone senza sottostare a regole, capace di donare modernità e raffinatezza.

A beauty that asserts itself without abiding by the rules, capable of giving modernity and sophistication.

DOGA MAX / MAX BOARD

6 x 228 x 1800 mm



Ritenuto essere uno dei deserti più antichi del mondo, il Namib attraversa tutta la zona costiera della Namibia, a cui dà il nome, cambiando la sua morfologia: da deserto roccioso a sconfinata estensioni di sabbia chiara.

Considered to be one of the most ancient deserts in the world, the Namib crosses the entire coastal area of Namibia, from which it gets changing its morphology: from rocky desert to limitless extension of light sand.

DÉCO INSPIRATION
NAMIB DESERT / NAMIBIA

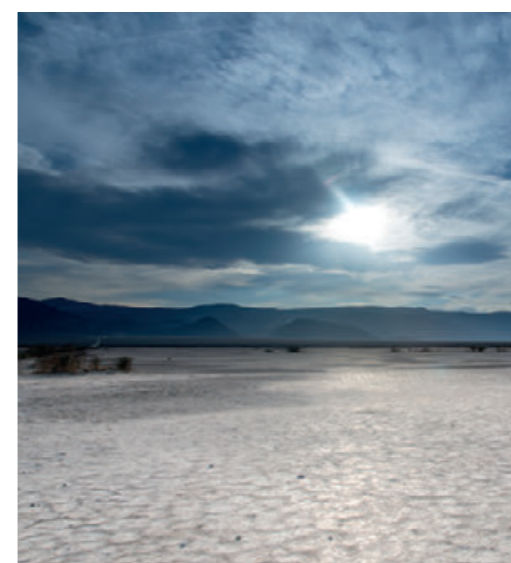

Guardando le sfarzose fontane e i giochi d'acqua dei casinò si fatica a credere che Las Vegas, la città dalle mille luci, sia in realtà immersa in un paesaggio desertico di rara bellezza.

Observing the lavish fountains and waterworks of the casinos, it is hard to believe that Las Vegas, the city of a thousand lights, is actually immersed in a desert landscape of rare beauty.

DÉCO INSPIRATION
DEATH VALLEY / NEVADA, USA



MARAN

Un aspetto discreto e sobrio che riesce ad esercitare un fascino magnetico proprio per la sua mirabile delicatezza.

A discreet and sober aspect able to exercise magnetic charm precisely for its wonderful gentleness.

DOGA MAX / MAX BOARD

6 x 228 x 1800 mm

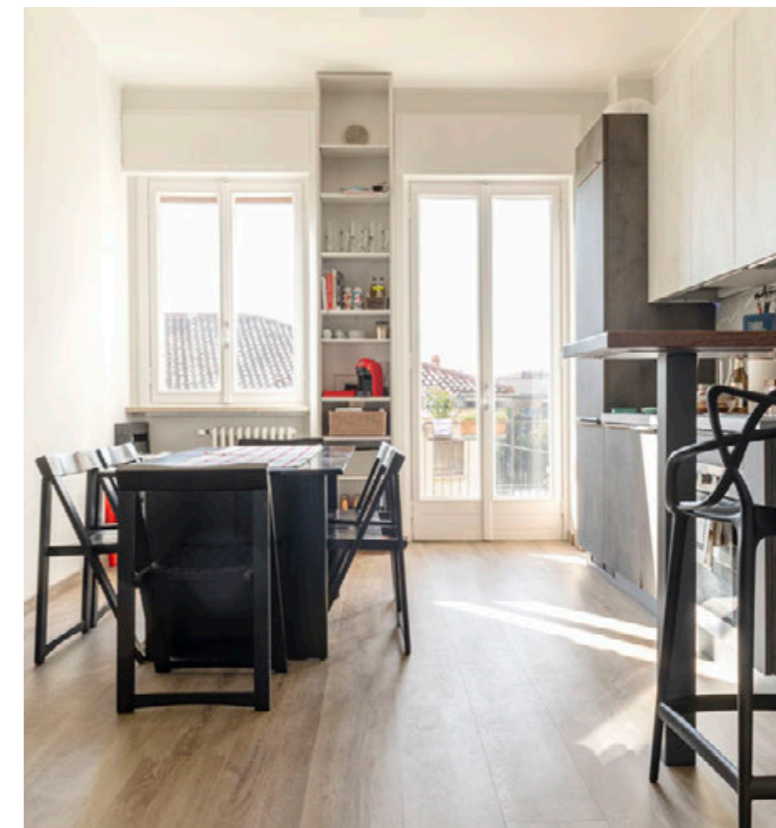

PATAGONIA

Indice di gusto e personalità, le marcate e suggestive sfumature riescono a trasmettere a colpo d'occhio la risolutezza di un carattere forte.

Indicator of taste and personality, the marked and evocative nuances are able to convey the determination of a strong personality at first glance.

DOGA MAX / MAX BOARD

6 x 228 x 1800 mm



Dune di sabbia bianca e lagune d'acqua: il Brasile nord-orientale ospita l'affascinante e sinuoso deserto Lençóis Maranhenses, il cui nome significa "lenzuoli del Maranhão" proprio perché le dune, viste dall'alto, ricordano i drappaggi dei pittori rinascimentali.

White sand dunes and lagoons of water: north-eastern Brazil is home to the fascinating and sinuous desert of the Lençóis Maranhenses, whose name means "bedsheets of Maranhão", just like the dunes which, seen from above, resemble the drapery of the Renaissance painters.

DÉCO INSPIRATION
LENÇÓIS MARANHENSES / BRASILE



Nel cuore del deserto della Patagonia, a sud dell'Argentina, si nasconde una delle più belle foreste pietrificate del mondo. In seguito a colossali eruzioni vulcaniche, i boschi che prima abitavano questa regione vennero completamente sepolti da uno strato di cenere e lava.

In the heart of the desert of Patagonia, south of Argentina, one of the most beautiful, petrified forests in the world is hidden. Following colossal volcanic eruptions, the forests which were first found in the region were all completely buried under a layer of ashes and lava.

DÉCO INSPIRATION
PATAGONIAN DESERT / ARGENTINA

CLAP!3D

STRUTTURA / STRUCTURE

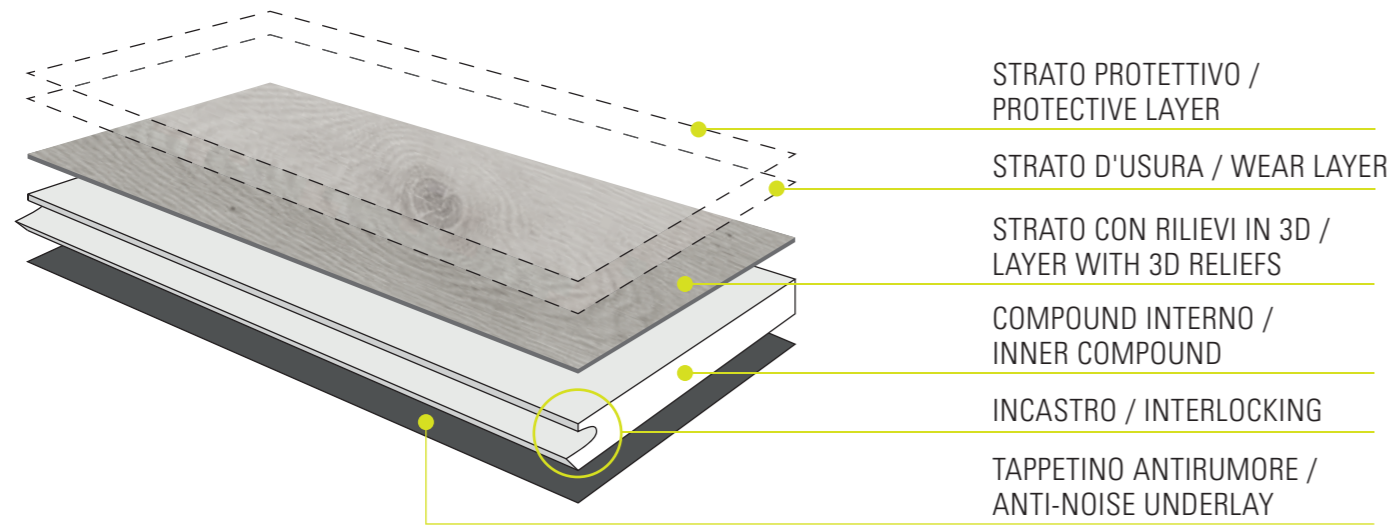

SISTEMA DI POSA A INCASTRO / INTERLOCKING INSTALLATION SYSTEM

L'innovativo sistema a incastro 5G brevettato permette una posa rapida e subito calpestabile anche su pavimenti esistenti e in case ammobiliate, senza l'utilizzo di collanti e senza necessitare di tempi di asciugatura.

The innovative 5G interlocking system allows for a quick installation immediately ready for foot traffic, also over existing flooring and in furnished homes, without requiring glue and without drying times.



CLAP!GO

VERSATILITÀ AL QUADRATO

Eclettica, articolata e accessibile.
La collezione Clap!GO libera la creatività
progettuale offrendo varietà di formati,
finiture effetto legno, marmo, pietra e cemento.

VERSATILITY SQUARED

Eclectic, structured and accessible.
The Clap!GO collection sets design creativity free
offering a variety of sizes, finishes wood,
stone and concrete effect.

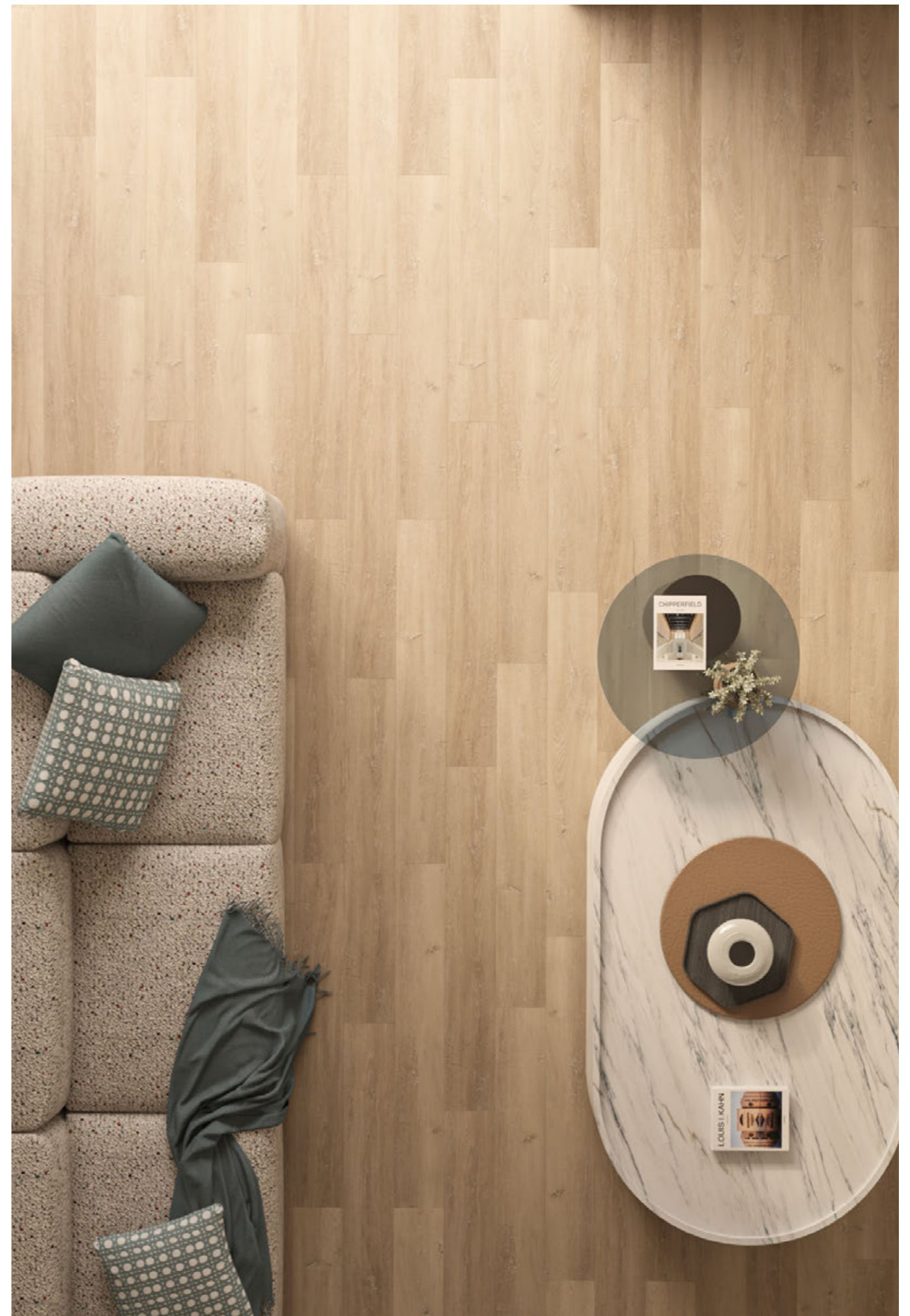



ELEGANTI FINITURE EFFETTO MARMO NEW MARBLE-EFFECT FINISHES

La collezione Clap!GoTiles offre tre nuove accattivanti colorazioni effetto marmo, in linea con le tendenze contemporanee. Passando dall'elegante grigio carnico a un bianco con venature a contrasto, le nuove Clap!GoTiles trasformano istantaneamente l'impatto estetico di qualsiasi spazio creando atmosfere sofisticate e ricercate.

The Clap!Go Tiles collection has been enhanced with three new captivating marble-effect colours, in line with current trends. Ranging from the elegant "Carnico gray" to a white with contrasting veins, the new Clap!Go Tiles instantly transform the visual impact of any space, creating a sophisticated and elegant atmosphere.



FINITURE EFFETTO LEGNO, PIETRA E MARMO WOOD, STONE AND MARBLE EFFECT FINISHINGS

Declinata in due formati, doghe effetto legno e piastrelle effetto pietra, marmo e cemento, la collezione Clap!GO offre una posa rapida a incastro, anche su pavimenti esistenti. Grazie alla loro praticità e versatilità, i rivestimenti Clap!GO consentono di rinnovare gli spazi con facilità, senza dover rimuovere il pavimento precedente, unendo estetica, funzionalità e comfort in un'unica soluzione.

Available in two formats, wood-effect planks and large tiles with stone, marble, and concrete finishes, the Clap!GO collection offers quick, click-installation, even over existing floors. Thanks to their practicality and versatility, Clap!GO coverings make it easy to refresh spaces without the need to remove the existing flooring, combining aesthetics, functionality, and comfort in one solution.

CLAP!GO BOARD

WOOD EFFECT

Ispirate alle foreste più suggestive della terra, le finiture della collezione Clap!GO coprono una vasta gamma di colorazioni offrendo tonalità effetto legno sia calde che fredde.

Inspired by the earth's most evocative forests, the Clap!GO collection finishes cover a wide range of colours offering both warm and cool wood-effect tones.

DOGA FLOOR / FLOOR BOARD

5 x 181 x 1220 mm



STANTON



LETEA



CADDO



TSINGY



SEQUOIA



MAUI

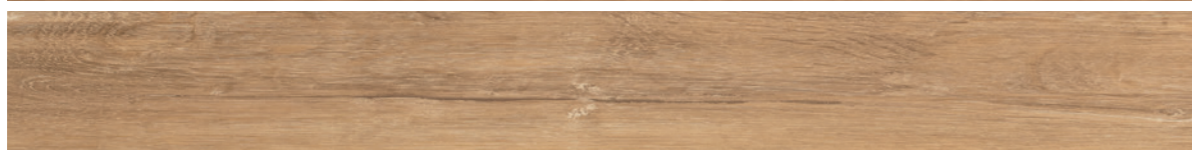

SPINOSA



RATA

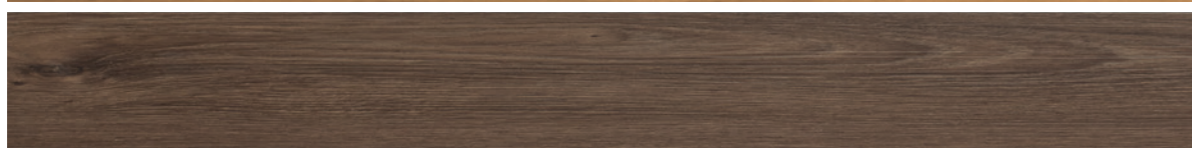

ITA
visualizza Clap!
a casa tua



ENG
visualize Clap!
in your space

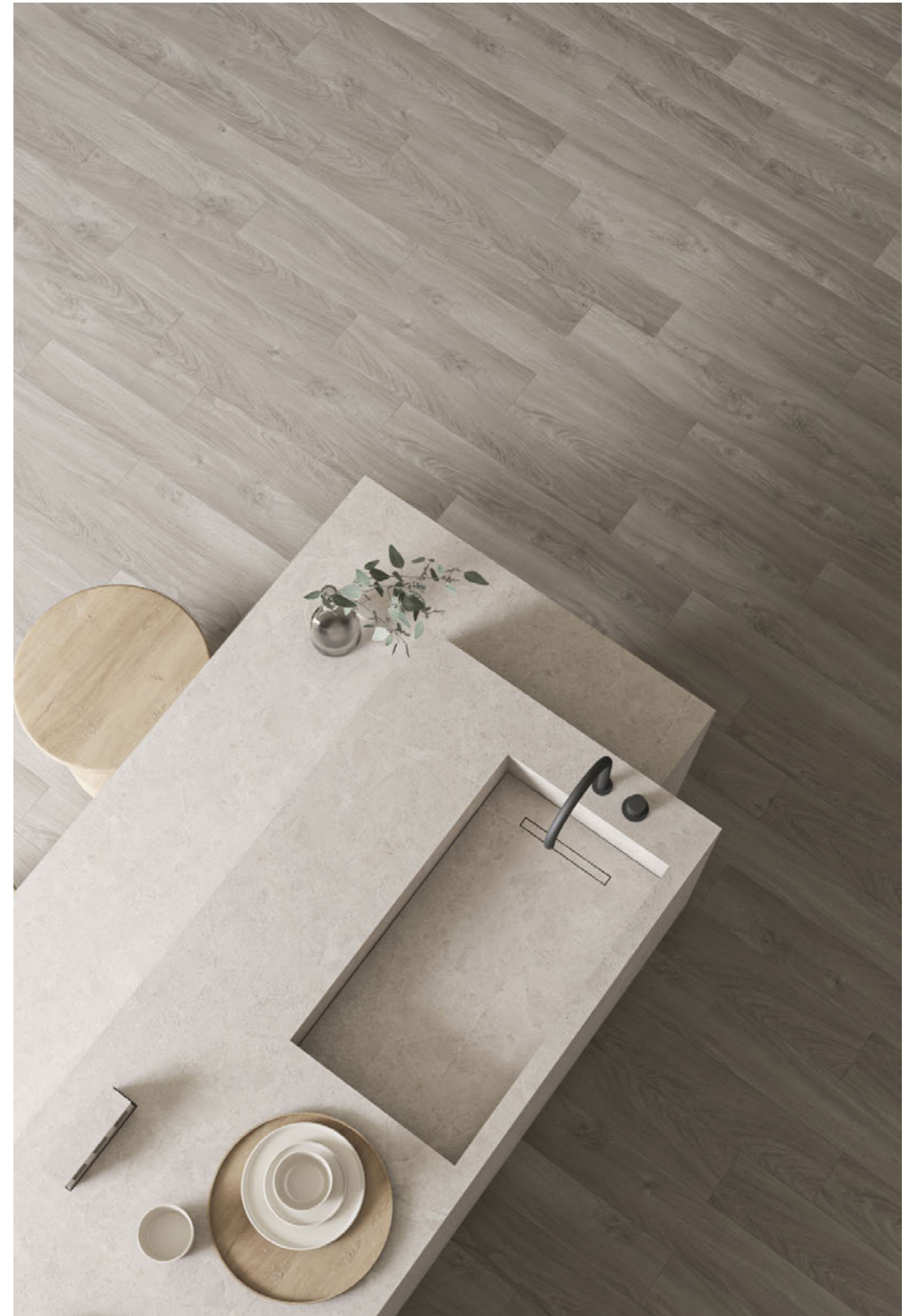



STANTON

Ideale per ambienti aperti e luminosi, una presenza discreta, non prevaricante, capace di scaldare lo spazio che lo ospita.

Ideal for open and bright environments, a significant presence, not overwhelming, capable of warming the space welcoming it.

DOGA FLOOR / FLOOR BOARD

5 x 181 x 1220 mm



LETEA

Una matericità raffinata offre calde variazioni cromatiche tono su tono che spaziano tra grigio e ocra.

A refined structure offers warm chromatic variations tone-on-tone which range from grey to okra.

DOGA FLOOR / FLOOR BOARD

5 x 181 x 1220 mm



La brughiera di Stanton Moor, nel nord dell'Inghilterra, ospita quattro misteriosi cerchi di pietra. Sono molte le leggende che circondano la foresta e le sue pietre, quasi tutte legate ai Druidi e al culto di qualche antica divinità.

In Stanton Moor, in northern England, there are four mysterious stone circles. There are many legends surrounding the forest and its stones, almost all tied to the Druids and the worship of some ancient gods.

DÉCO INSPIRATION
STANTON MOOR FOREST / UNITED KINGDOM



Con cavalli selvaggi, viti, querce di 700 anni e dune di sabbia, Letea è la foresta subtropicale più settentrionale del mondo. Lontano dagli occhi e dai percorsi turistici, la foresta nasconde molti segreti custoditi con cura.

With wild horses, vines, 700-year-old oak trees and sand dunes, Letea is the northernmost subtropical forest in the world. Far from the eyes and tourism itineraries, the forest hides many secrets carefully safeguarded.

DÉCO INSPIRATION
LETEA FOREST / ROMANIA



CADDO

Il calore delle doghe si trasforma in comfort, lo spazio assume peculiarità uniche e gli ambienti rinascono.

The heat of the boards transforms into comfort, the space takes on unique characteristics and the environments are revived.

DOGA FLOOR / FLOOR BOARD

5 x 181 x 1220 mm

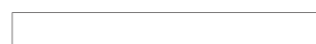

WOOD EFFECT



TSINGY

Forte personalità per un prodotto subito riconoscibile che trasmette un vissuto evidente, capace di rendersi protagonista.

Strong personality for a product that is immediately recognisable and which conveys an evident past capable of becoming a protagonist.

DOGA FLOOR / FLOOR BOARD

5 x 181 x 1220 mm



WOOD EFFECT



Questo affascinante labirinto di corsi d'acqua, paludi, isole, baie, canali e boschetti di cipressi che grondano di muschio spagnolo, prende il nome dai nativi americani chiamati Caddo Indians.

This charming labyrinth of waterways, swamps, islands, bays, canals and cypress forests dripping with Spanish moss, takes its name from the native Americans called Caddo Indians.

DÉCO INSPIRATION
CADDO FOREST / TEXAS, US



In malgascio tsingy significa 'dove non si può camminare scalzi'. La riserva naturale Tsingy de Bemaraha, patrimonio mondiale dell'UNESCO, è il più grande esempio di foresta tsingy sulla Terra, che include una vera e propria cattedrale di pietra calcarea.

In Malagasy, tsingy means 'where you cannot walk barefoot'. The Tsingy de Bemaraha nature reserve, UNESCO world heritage site, is the largest example of a tsingy forest on earth, including an actual limestone cathedral.

DÉCO INSPIRATION
TSINGY NATURE RESERVE / MADAGASCAR



SEQUOIA

Il calore tipico del rovere, riproposto conservando le principali caratteristiche che lo rendono unico e identificabile.

The typical warmth of oak represented maintaining the main characteristics that make it unique and identifiable.

DOGA FLOOR / FLOOR BOARD

5 x 181 x 1220 mm



MAUI

Una profondità materica inedita resa possibile dalla distribuzione uniforme di elementi schiariti all'interno del pattern.

A material depth never-before-seen made possible by the uniform distribution of elements lightened within the pattern.

DOGA FLOOR / FLOOR BOARD

5 x 181 x 1220 mm



Questo paesaggio drammatico testimonia le dimensioni, la bellezza e la diversità della natura: montagne enormi, colline rocciose, canyon profondi, vaste caverne e gli alberi più grandi del mondo.

This dramatic landscape shows the dimensions, beauty and diversity of nature: enormous mountains, rocky hills, deep canyons, vast caves and the biggest trees in the world.

DÉCO INSPIRATION
SEQUOIA NATIONAL PARK / CALIFORNIA, US



È difficile credere ai propri occhi attraversando questa foresta: lungo il tragitto che la percorre si avvicendano boschetti di Eucalipto Arcobaleno, una specie di pianta molto particolare che si trova solo su questa isola delle Hawaii.

It is difficult to believe one's eyes crossing this forest: along the way, you meet woods of rainbow eucalyptus, a very particular species of plant found only on this island in Hawaii.

DÉCO INSPIRATION
PAINTED FOREST / HAWAII, US



SPINOSA

Venature longilinee ed equilibrate che evocano l'affabilità del migliore teak birmano, con colori mielati e seducenti.

Slender and balanced grains that evoke the reliability of the best Burmese teak, with honeyed and seductive colours.

DOGA FLOOR / FLOOR BOARD

5 x 181 x 1220 mm



RATA

Una presenza avvolgente e incisiva che conferisce allo spazio in cui si innesta un gusto sobrio e suadente.

An enveloping and significant presence that gives the space where it is included a serious and mellow taste.

DOGA FLOOR / FLOOR BOARD

5 x 181 x 1220 mm



La foresta Spinosa è un luogo unico sulla Terra. La vegetazione è animata da una fauna molto particolare, sviluppatasi grazie all'accentuata biodiversità. All'interno della foresta si possono distinguere diverse aree: le tante precipitazioni incostanti hanno reso il suolo irregolare e dato vita a molteplici specie animali e vegetali.

The Spiny Forest is a unique place on earth. The vegetation includes a very particular fauna, developed thanks to the accentuated biodiversity. Various areas are found within the forest: the rainfall is erratic making the soil irregular and has led to many animal and vegetable species.

DÉCO INSPIRATION
SPINOSA FOREST / MADAGASCAR



La Rata è un tipo di albero molto comune in Nuova Zelanda, con un tipico sviluppo nodoso. Questa foresta si trova sull'isola di Enderby ed è ricca di tronchi con forti nodi, i cui rami creano un intrico fiabesco.

The Rata is a tree typical of New Zealand, with a typical knobby development. This forest is found on the island of Enderby and is rich in trunks with strong knots, whose branches create a fairytale entanglement.

DÉCO INSPIRATION
RATA FOREST / NEW ZELAND

CLAP!GO BOARD WOOD EFFECT

STRUTTURA, FORMATO, SOLUZIONI DI POSA /
STRUCTURE, SIZE, INSTALLATION SOLUTIONS

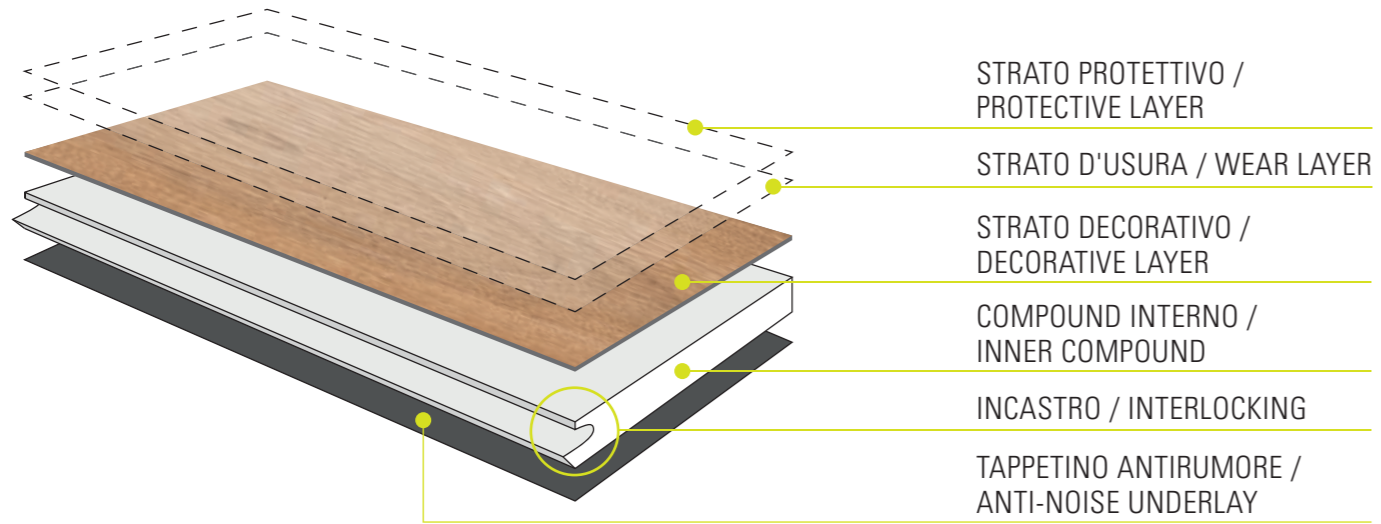

DOGA FLOOR / FLOOR BOARD

5 x 181 x 1220 mm



SISTEMA DI POSA A INCASTRO / INTERLOCKING INSTALLATION SYSTEM

L'innovativo sistema a incastro Smart brevettato permette una posa rapida e subito calpestabile anche su pavimenti esistenti e in case ammobiliate, senza l'utilizzo di collanti e senza necessitare di tempi di asciugatura.

The innovative, patented Smart interlocking system allows for quick installation, for immediate foot traffic, also over existing flooring and in furnished houses, without requiring glue and drying times.

Schema classico per Doga Floor
con sfalsatura di min 30cm.

Classic layout for Floor Board
with 30cm staggering.

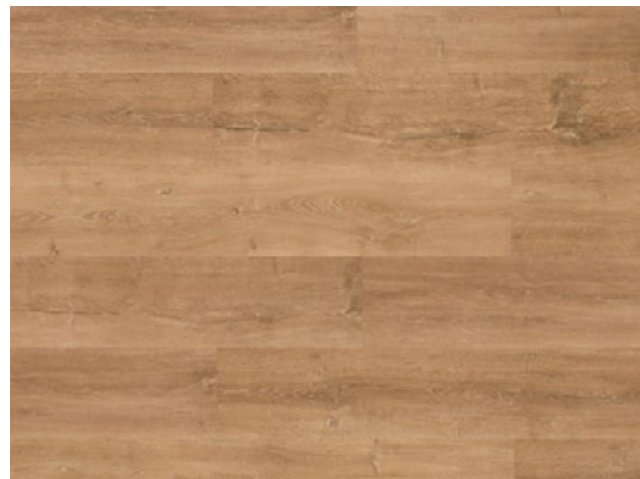
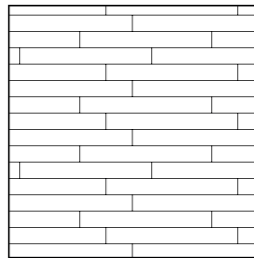

CLAP!GO TILES

STONE AND MARBLE EFFECT

Disponibili in varie nuance cromatiche, le piastrelle effetto pietra, cemento e marmo completano la gamma Clap!GO con texture materiche ispirate alla pietra naturale.

Available in various chromatic nuances, the tiles with stone, concrete and marble effect complete the Clap!GO range with material textures inspired by natural stones.

ITA 
visualizza Clap!
a casa tua

ENG 
visualize Clap!
in your space



**PIASTRELLA FLOOR/
TILE FLOOR**
7 x 465 x 940 mm

AMA



GERIA



MIRI



MONO

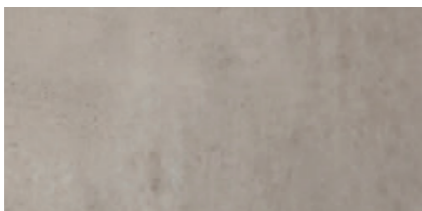

KUN



ZURI

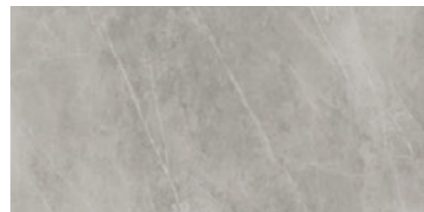

MARTIS

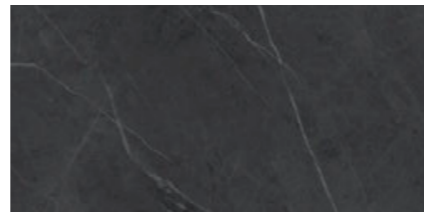

RUSK





AMA

Le tonalità misurate e leggere della pietra veicolano una compostezza ideale per ogni contesto e tipo di ambiente.

The measured and light tones of the stone convey an ideal composure for every context and type of environment.

PIASTRELLA / TILE

7 x 465 x 940 mm



STONE EFFECT



Conosciuto come il Cervino dell'Himalaya, Ama Dablam è un picco spaventoso che sale a 6.856 metri di altezza ed è una delle montagne più spettacolari al mondo, oltre che un vero sogno per gli alpinisti.

Known as the Matterhorn of the Himalayas, Ama Dablam is a terrifying peak rising 6,856 metres high and is one of the most spectacular mountains in the world, in addition to a real dream for mountaineers.

DÉCO INSPIRATION
AMA DABLAM MOUNTAIN / NEPAL

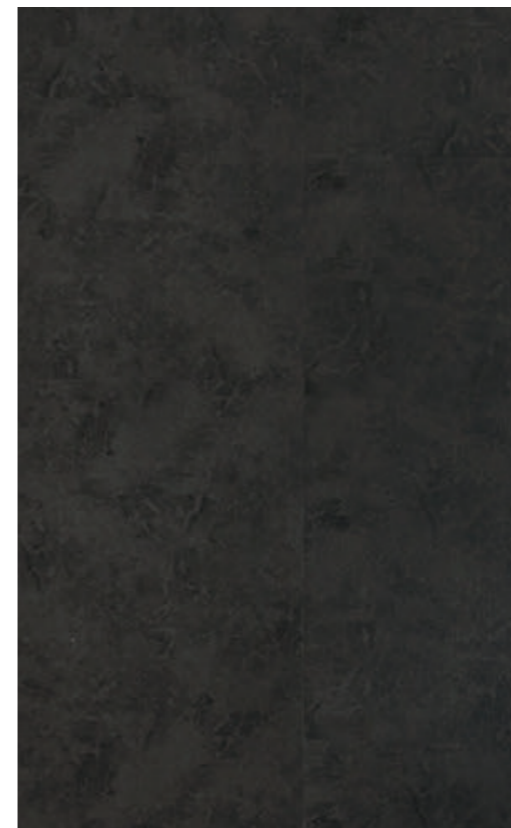

GERIA

Il look austero di Geria, contestualmente fermo ed essenziale, conferisce ad ogni ambiente gusto e stile senza uguali.

The austere look of Geria, motionless and essential at the same time, gives every space an unrivalled sense of taste and style.

PIASTRELLA / TILE

7 x 465 x 940 mm



STONE EFFECT



Il termine 'geria' indica la buca conica scavata nella ghiaia vulcanica e bordata di rocce che permette di trattenere la poca acqua disponibile. Grazie a questa ingegnosa tecnica, a Lanzarote si riesce in un'impresa che ha dell'impossibile: coltivare la vite nel cuore di un paesaggio lavico.

'Geria' represents the conical hole dug in the volcanic gravel and bordered with rocks that makes it possible to retain the little water available. Thanks to this ingenious technique, in Lanzarote, an almost impossible feat takes place: vine is cultivated in the heart of a lava landscape.

DÉCO INSPIRATION
LA GERIA / LANZAROTE, SPAIN



MIRI

Un candore eclettico e adatto a più stili e personalità: le tonalità nivee e luminose dei profili della famiglia Miri valorizzano al massimo interni sia classici che moderni.

An eclectic purity, suitable to various styles and personalities: the snowy-white, luminous shades of the Miri family greatly enhance both classic and modern interiors.

PIASTRELLA / TILE

7 x 465 x 940 mm



STONE EFFECT



MONO

Un color tortora con tonalità tra l'avena e il rosato, perfetto per donare all'ambiente un calore unico, discreto e delicato.

A dove-grey colour with shades ranging between beige and pink, perfect to give an environment a unique, subtle and delicate warmth.

PIASTRELLA / TILE

7 x 465 x 940 mm



STONE EFFECT



Il Parco Nazionale di Gunung Mulu di Miri, nel Borneo malese, è una vera e propria città di pietra: grotte, cunicoli e pinnacoli di roccia che ricordano dei grattacieli. Un ambiente naturale dal fascino senza pari.

The Gunung Mulu National Park in Miri in the Malaysian Borneo is an actual city of stone: grottos, tunnels and pinnacles of rock that look like skyscrapers. A natural environment with unparalleled charm.

DÉCO INSPIRATION

MIRI GUNGUNG MULU NATIONAL PARK / MALAYSIA



Vicino alla città greca di Monodendri delle rocce colossali si raccolgono in quella che, in loro onore, è stata chiamata Stone Forest. Pilastrini megalitici modellati dalla natura in vere e proprie sculture: un miracolo di pietra.

Near the Greek city of Monodendri, grand rocks are found in an area named Stone Forest in their honour. Megalithic columns modelled by nature into actual sculptures: a miracle of stone.

DÉCO INSPIRATION

MONODENDRI STONE FOREST / GREECE



KUN

Scelta ideale per dare vita ad ambienti unici, dall'atmosfera sobria e risoluta. Una tonalità neutra che ben si sposa ad un'estetica minimal.

Ideal choice to give life to unique environments, with a simple and strong atmosphere. A neutral tone that goes very well with a minimal aesthetic.

PIASTRELLA / TILE

7 x 465 x 940 mm



ZURI

Con sottili striature bianche, Zuri ricorda il marmo Grigio Carnico chiaro, un elemento distintivo che trasmette un senso di classe e bellezza senza tempo.

With minute white streaks, Zuri resembles light Grigio Carnico marble, a distinctive element that conveys a sense of class and timeless beauty.

PIASTRELLA / TILE

7 x 465 x 940 mm



Nella Cina meridionale, nei pressi di Kunming, enormi formazioni calcaree si innalzano verso il cielo ricordando degli altissimi alberi di pietra. Uno spettacolo così grandioso che l'occhio umano fatica a sostenere.

In Southern China, near Kunming, enormous limestone formations rise toward the sky resembling very tall, stone trees. A sight so magnificent that the human eye has a hard time taking in.

DÉCO INSPIRATION

KUNMING SHILIN STONE FOREST / CHINA



La Foresta pietrificata di Zuri-Soddì in Sardegna si presenta come un affascinante e unico spettacolo naturale, dove alberi pietrificati risplendono in una varietà di colori terrosi, testimoni silenziosi di un passato geologico lontano.

The Zuri-Soddì Petrified Forest in Sardinia presents itself as a fascinating and unique natural spectacle, where petrified trees shine in a variety of earthy colors, silent witnesses to a distant geological past.

DÉCO INSPIRATION

ZURI-SODDÌ PETRIFIED FOREST / SARDINIA



MARTIS

Elegantemente scura, la finitura Martis è arricchita da sottili e rade venature bianche che creano un contrasto sofisticato e distintivo.

Elegantly dark, the Martis finish is enriched with fine and sparse white veins that create a sophisticated and distinctive contrast.

PIASTRELLA / TILE

7 x 465 x 940 mm

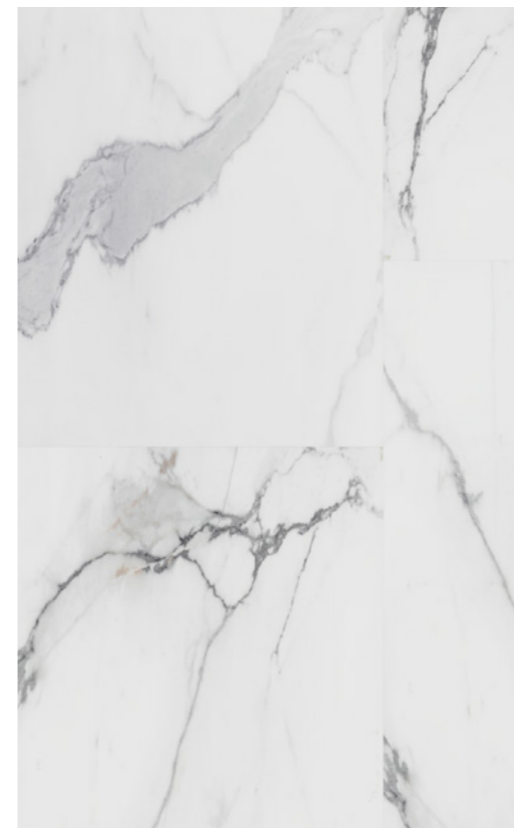

RUSK

La finitura Rusk, ispirata al marmo bianco impreziosito da raffinate screziature grigio-nere a contrasto, è perfetta per conferire un tocco di prestigio e modernità a qualsiasi spazio.

The Rusk finish, inspired by white marble adorned with refined contrasting gray-black streaks, is perfect for adding a touch of prestige and modernity to any space.

PIASTRELLA / TILE

7 x 465 x 940 mm



Questo affascinante sito archeologico naturale cattura l'attenzione con la sua storia, regalando una prospettiva affascinante sulla lunga evoluzione del paesaggio sardo.

This charming natural archaeological site captures attention with its history, providing a fascinating perspective on the long evolution of the Sardinian landscape.

DÉCO INSPIRATION

MARTIS PETRIFIED FOREST / SARDINIA



Il Ruskeala Park in Russia è un'affascinante oasi naturale situata nelle vicinanze di Sortavala, celebre per le sue cave di marmo abbandonate che hanno dato origine a uno spettacolare paesaggio di laghi azzurri circondati da imponenti scogliere.

Ruskeala Park in Russia is a captivating natural oasis located near Sortavala, renowned for its abandoned marble quarries that have given rise to a spectacular landscape of blue lakes surrounded by imposing cliffs.

DÉCO INSPIRATION

RUSKEALA PARK / RUSSIA

CLAP!GO PIASTRELLA / TILE STONE-MARBLE EFFECT

STRUTTURA, FORMATO, SOLUZIONI DI POSA /
STRUCTURE, SIZE, INSTALLATION SOLUTIONS

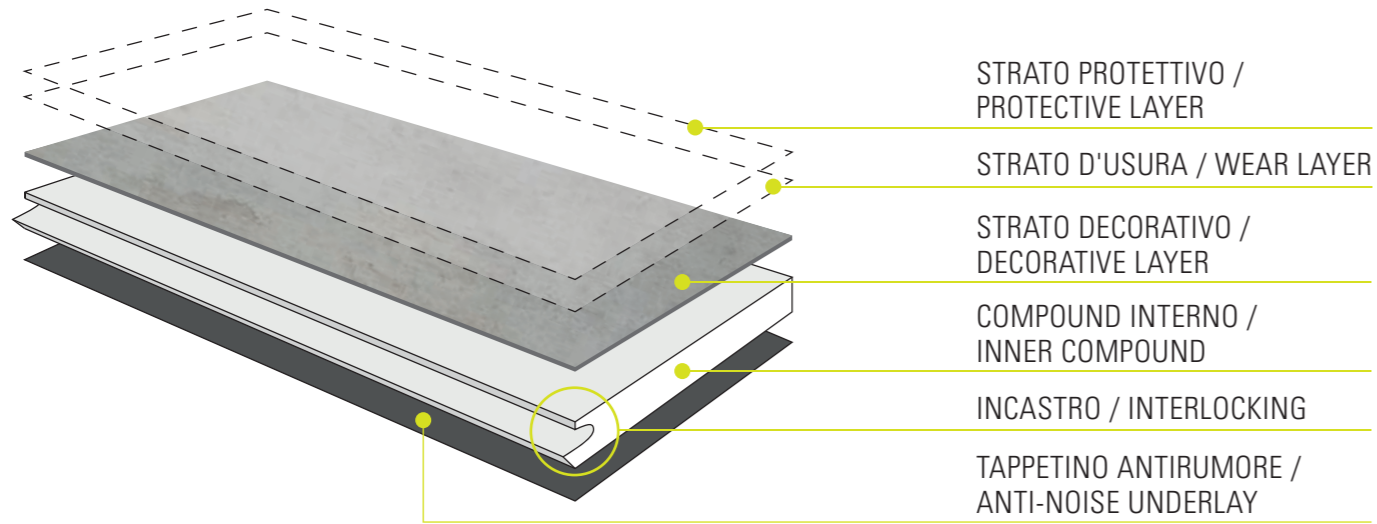

PIASTRELLA / TILE

7 x 465 x 940 mm



SISTEMA DI POSA A INCASTRO / INTERLOCKING INSTALLATION SYSTEM

L'innovativo sistema a incastro 5G brevettato permette una posa rapida e subito calpestabile anche su pavimenti esistenti e in case arredate, senza l'utilizzo di collanti e senza necessitare di tempi di asciugatura.

The innovative 5G interlocking system allows for a quick installation immediately ready for foot traffic, also over existing flooring and in furnished homes, without requiring glue and without drying times.

Schema classico per Piastrella con
sfalsatura di min 30cm.

Classic layout for tile with
30cm staggering.

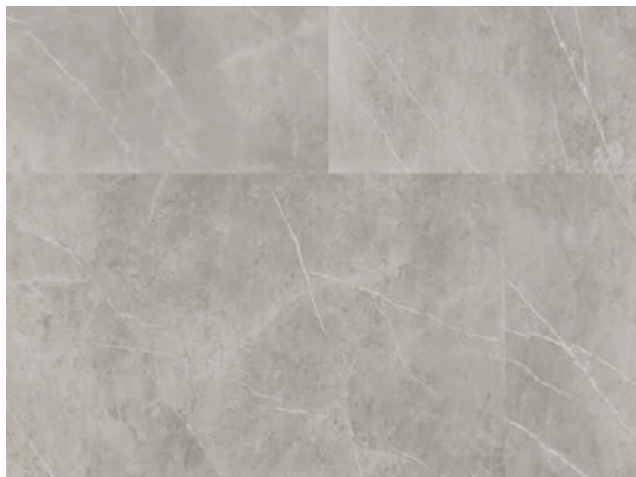
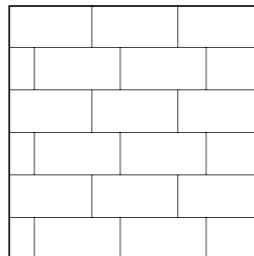

CLAP!WALL

L'INNOVAZIONE DEL RIVESTIMENTO A PARETE

La nuova famiglia Clap!WALL rivoluziona il mondo dei rivestimenti a parete con soluzioni eleganti e funzionali, pensate per ogni esigenza di design. Con finiture effetto legno, pietra, marmo e cemento che garantiscono continuità estetica con i pavimenti della linea Clap!GO, la collezione Clap!WALL si articola in tre linee distinte pensate per offrire una varietà di sistemi di rivestimento verticale in grado di trasformare gli ambienti con stile e coerenza visiva.

THE INNOVATION OF WALL CLADDING

The new Clap!WALL family revolutionizes the world of wall coverings with elegant and functional solutions designed to meet every design need. Featuring wood, stone, marble, and concrete-effect finishes that ensure aesthetic continuity with the Clap!GO flooring line, the Clap!WALL collection is divided into three distinct lines, offering a variety of vertical cladding systems capable of transforming spaces with style and visual harmony.





AMPIA GAMMA DI FORMATI WIDE RANGE OF FORMATS

La collezione Clap!WALL si articola in tre linee distinte: Clap!WALL Board, con doghe effetto legno che garantiscono continuità estetica con i pavimenti della linea Clap!GO; Clap!WALL Tiles, una selezione di piastrelle effetto pietra, marmo e cemento, progettate per creare armonia cromatica con i rivestimenti a pavimento; e Clap!WALL Panels, maxi-pannelli effetto marmo ideali per coprire ampie superfici, unendo imponenza visiva e facilità di posa. Ogni linea offre soluzioni versatili che trasformano gli ambienti con stile e coerenza.

- **Clap!WALL Board** - doghe effetto legno per pareti *
- **Clap!WALL Tiles** - piastrelle effetto pietra, marmo, cemento per pareti *
- **Clap!WALL Panels** - maxi-pannelli effetto marmo per rivestimenti verticali

The Clap!WALL collection is divided into three distinct lines: Clap!WALL Board, featuring wood-effect slats that ensure seamless aesthetic continuity with Clap!GO flooring; Clap!WALL Tiles, a selection of stone, marble, and concrete-effect tiles designed to create perfect color harmony with the flooring; and Clap!WALL Panels, marble-effect maxi-panels ideal for covering large surfaces, combining visual impact with easy installation. Each line offers versatile solutions that transform spaces with style and consistency.

- **Clap!WALL Board** - wood-effect slats for walls*
- **Clap!WALL Tiles** - stone, marble, and concrete-effect tiles for walls*
- **Clap!WALL Panels** - marble-effect maxi-panels for vertical cladding

CLAP!WALL PANELS

4 x 1100 x 2800 mm



CLAP!WALL TILES

5 x 465 x 940 mm



CLAP!WALL BOARD

3 x 130 x 1226 mm



* Continuità cromatica con i pavimenti della linea Clap!GO
Seamless color continuity with Clap!GO flooring.



CLAP!WALL PANELS
LA NUOVA LINEA DI PANNELLI
MURALI EFFETTO MARMO
CLAP!WALL PANELS
THE NEW MARBLE-EFFECT
WALL PANEL LINE

NEW

La nuova collezione Clap!WALL Panels rappresenta un'innovazione nel design dei rivestimenti per pareti. Pensata per chi desidera rivestire ampie superfici con finiture effetto marmo, Clap!WALL Panels offre eleganza e praticità di posa grazie allo spessore ridotto di soli 4mm. Realizzati in pietra e polimeri come gli altri prodotti della famiglia Clap!, i maxi-pannelli Clap!WALL Panels offrono una soluzione innovativa per ambienti residenziali e contract, garantendo prestazioni elevate e un design sofisticato.

The new Clap!WALL Panels collection is a groundbreaking innovation in wall covering design. Designed for those who want to cover large surfaces with marble-effect finishes, Clap!WALL Panels combines elegance with easy installation, thanks to its slim 4mm thickness. Made from stone and polymers, like other products in the Clap! family, these large panels offer an innovative solution for both residential and commercial spaces, ensuring high performance and sophisticated design.



CLAP!WALL PANELS* MARBLE EFFECT



* disponibili da primavera 2025
available from spring 2025

Traendo ispirazione da catene montuose di maestosa bellezza, la collezione Clap!WALL Panels propone cinque eleganti finiture effetto marmo. Le tonalità spaziano dal raffinato Calacatta, in due varianti, al grigio, fino a due sfumature di nero, per offrire un'ampia scelta di soluzioni di stile.

Drawing inspiration from mountain ranges of majestic beauty, the Clap!WALL Panels collection offers five elegant marble-effect finishes. The shades range from the refined Calacatta, in two variations, to gray, and two shades of black, providing a wide selection of stylish options.



PANNELLO / PANEL
4 x 1100 x 2800 mm

HIMA



ALPI

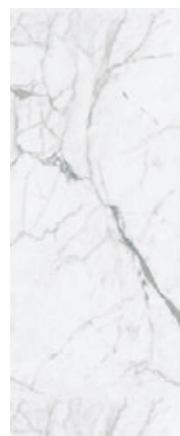

KORUM

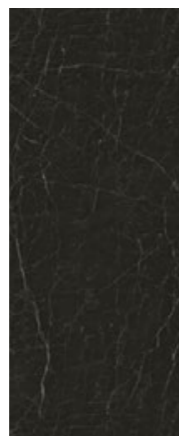

YUNNA

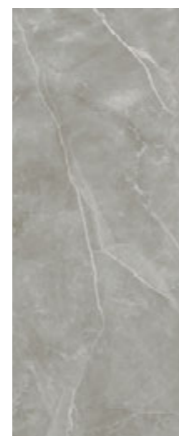

SIERRA



Nota: I maxi-pannelli Clap!WALL Panels sono realizzati secondo elevati standard qualitativi e tecnologici. Sono da considerarsi normali, nel processo produttivo, delle piccolissime inclusioni d'aria a livello superficiale. Rispetto agli standard di mercato, i Clap!WALL Panels si distinguono per una resa estetica superiore di cui gli stringenti controlli di qualità garantiscono inclusioni estremamente rare (massimo 3 per metro lineare) e dalle dimensioni inferiori al millimetro.

Note: Clap!WALL Panels are manufactured to high quality and technological standards. Very small air inclusions at surface level are to be considered normal in the production process. Compared to market standards, Clap!WALL Panels are distinguished by superior aesthetics, for which stringent quality controls guarantee extremely rare inclusions (maximum 3 per linear metre) and dimensions of less than a millimetre.



INNOVAZIONE E PRATICITÀ IN FORMATO MAXI INNOVATION AND PRACTICALITY IN MAXI FORMAT

Con dimensioni di 1100x2800mm e uno spessore di soli 4mm, Clap!WALL Panels offre una leggerezza senza pari, pur mantenendo la resistenza e la durabilità del materiale di cui sono composte. La loro installazione è estremamente semplice, permettendo di ottenere risultati impeccabili in modo pratico e veloce.

With dimensions of 1100x2800mm and a thickness of just 4mm, Clap!WALL Panels offers unparalleled lightness while maintaining the strength and durability of its material. Installation is extremely simple, allowing for impeccable results in a practical and fast way.



FINITURE EFFETTO MARMO DAL FINISH GLOSSY E MATTE MARBLE-EFFECT FINISHES WITH GLOSSY AND MATTE FINISHES

Le cinque finiture della collezione, dal finish glossy o matte, esplorano le sfumature più eleganti del marmo, offrendo una gamma che spazia dai classici marmi calacatta al grigio carnico, con l'aggiunta di due varianti di nero, perfette per creare contrasti moderni ed esclusivi. Perfette per ogni tipo di ambiente, i rivestimenti Clap!WALL Panels sono ideali non solo per abitazioni private, ma anche per contesti contract, come ristoranti e hotel, dove l'estetica sofisticata si unisce alla funzionalità.

The collection's five finishes, with glossy or matte effect, explore the most elegant shades of marble, offering a range that spans from classic calacatta marbles to Carnic grey, with the addition of two black variants, perfect for creating modern and exclusive contrasts. Suitable for any environment, Clap!WALL Panels are ideal not only for private residences but also for contract settings, such as restaurants and hotels, where sophisticated aesthetics meet functionality.



HIMA*

Un'eleganza che si distingue per la sua purezza e raffinatezza: la finitura Hima offre un effetto marmo bianco luminoso, arricchito da venature grigie profonde e marcate che si intrecciano armoniosamente.

An elegance that stands out for its purity and refinement: the Hima finish offers a luminous white marble effect, enriched with deep marked grey veins that intertwine harmoniously.



PANNELLO / PANEL
4 x 1100 x 2800 mm

FINITURA / FINISH:
Glossy / Matte

* disponibili da primavera 2025
available from spring 2025



ALPI*

Sobria e sofisticata, la finitura Alpi presenta un delicato bianco, solcato da venature grigie appena accennate che donano un tocco di delicata raffinatezza.

Sober and sophisticated, the Alpi finish features a delicate greyish-white, marked by faint veins that add a touch of subtle refinement.



PANNELLO / PANEL
4 x 1100 x 2800 mm

FINITURA / FINISH:
Glossy / Matte

* disponibili da primavera 2025
available from spring 2025



Maestosa e imponente, la Mahalangur Himal ospita le vette più alte del mondo, tra cui l'Everest. Paesaggi spettacolari, ghiacciai eterni e panorami vertiginosi ne fanno un simbolo di grandezza naturale e spirituale, un regno di ghiaccio che sfida l'uomo e il tempo.

Majestic and imposing, the Mahalangur Himal hosts the world's highest peaks, including Everest. Spectacular landscapes, eternal glaciers, and dizzying views make it a symbol of natural and spiritual grandeur, an icy realm that challenges both man and time.

DÉCO INSPIRATION
MAHALANGUR HIMAL / NEPAL



Le Alpi, con le loro vette maestose e i paesaggi variegati, rappresentano il cuore della natura italiana. Tra cime innevate e valli verdi, offrono uno scenario di rara bellezza che ispira rispetto e ammirazione, unendo natura selvaggia e cultura millenaria.

The Alps, with their majestic peaks and varied landscapes, represent the heart of Italian nature. Between snow-capped summits and green valleys, they offer a breathtaking scenery that inspires respect and admiration, blending wild nature with millennia of culture.

DÉCO INSPIRATION
ALPI / ITALY



KORUM*

Korum incarna l'essenza del marmo nero più puro. La superficie è attraversata da rade venature sottili, che emergono con discrezione, creando un effetto raffinato e contemporaneo.

Korum embodies the essence of the purest black marble. The surface is crossed by sparse, delicate veins that emerge discreetly, creating a refined and contemporary effect.

PANNELLO / PANEL
4 x 1100 x 2800 mm

FINITURA / FINISH:
Glossy / Matte

* disponibili da primavera 2025
available from spring 2025



YUNNA*

La finitura Yunna esalta il perfetto equilibrio tra delicatezza e forza, con un effetto marmo grigio impreziosito da screziature chiare che conferiscono dinamismo e profondità a qualsiasi ambiente.

The Yunna finish highlights the perfect balance between delicacy and strength, featuring a grey marble effect enhanced with light veining that adds dynamism and depth to any space.

PANNELLO / PANEL
4 x 1100 x 2800 mm

FINITURA / FINISH:
Glossy / Matte

* disponibili da primavera 2025
available from spring 2025



Aspra e monumentale, la catena del Karakoram custodisce alcuni dei ghiacciai più estesi del pianeta. Vette imponenti come il K2 sfidano l'orizzonte, rappresentando un luogo di sublime bellezza e di inaccessibile grandezza che incanta e intimorisce.

Rugged and monumental, the Karakoram range hosts some of the planet's largest glaciers. Majestic peaks such as K2 challenge the horizon, representing a place of sublime beauty and inaccessible grandeur that both enchants and intimidates.

DÉCO INSPIRATION
KARAKORAM / PAKISTAN, INDIA, CHINA



Le montagne dello Yunnan, con i loro profili sinuosi e avvolti da nebbie mistiche, offrono paesaggi di rara poesia. Un incontro tra natura selvaggia e tradizione, dove cime spettacolari si fondono con terrazze verdi, creando un'armonia incantevole.

The mountains of Yunnan, with their sinuous profiles wrapped in mystical mists, offer landscapes of rare poetry. A meeting between wild nature and tradition, where spectacular peaks merge with green terraces, creating an enchanting harmony.

DÉCO INSPIRATION
YUNNAN / CHINA

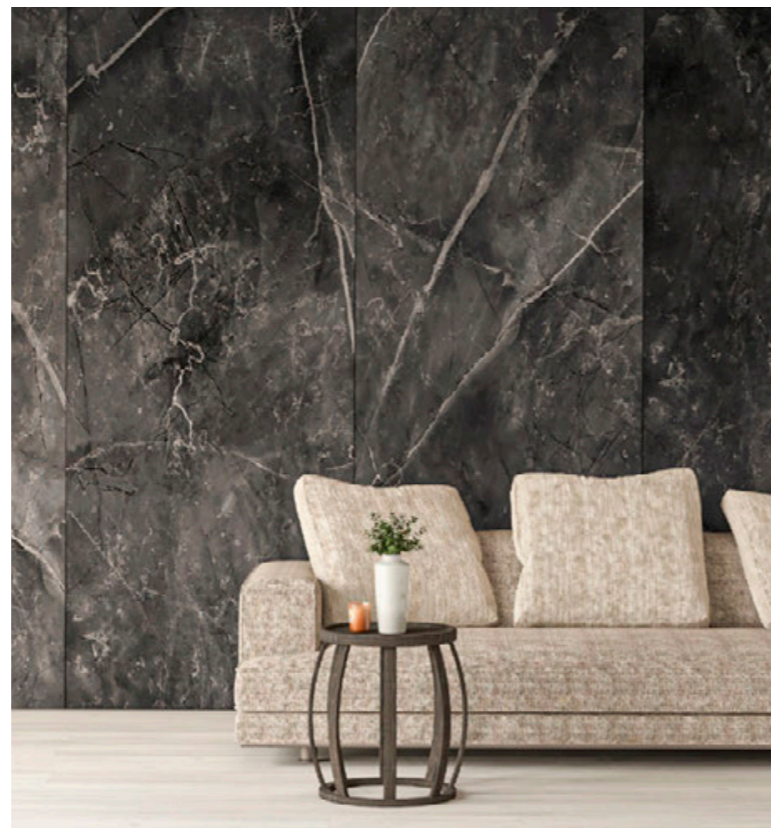

SIERRA*

Profonda e magnetica, Sierra è una celebrazione delle tonalità più intense. Il grigio scuro, quasi nero, è attraversato da sfumature chiare che creano un gioco di contrasti sofisticato e avvolgente.

Deep and magnetic, Sierra is a celebration of the most intense tones. Dark grey, almost black, is crossed by light hues that create a sophisticated and enveloping contrast.

PANNELLO / PANEL

4 x 1100 x 2800 mm

FINITURA / FINISH:

Glossy / Matte

* disponibili da primavera 2025
available from spring 2025



Maestosa e suggestiva, la Sierra Nevada si staglia con vette imponenti e paesaggi di straordinaria bellezza. Questa catena montuosa, con le sue cime innevate e i villaggi bianchi, rappresenta un equilibrio perfetto tra natura incontaminata e tradizione culturale.

Majestic and evocative, the Sierra Nevada stands out with its imposing peaks and landscapes of extraordinary beauty. This mountain range, with its snow-capped summits and white villages, represents the perfect balance between unspoiled nature and cultural tradition.

DÉCO INSPIRATION
SIERRA NEVADA / SPAIN



CLAP!WALL TILES

STONE EFFECT

Disponibili in varie nuance cromatiche, le piastrelle effetto pietra, cemento e marmo completano la gamma Clap!WALL con texture materiche ispirate alla pietra naturale.

Available in various chromatic nuances, the tiles with stone, concrete and marble effect complete the Clap!WALL range with material textures inspired by natural stones.



**PIASTRELLA WALL /
TILE WALL**
5 x 465 x 940 mm

AMA



GERIA



MIRI

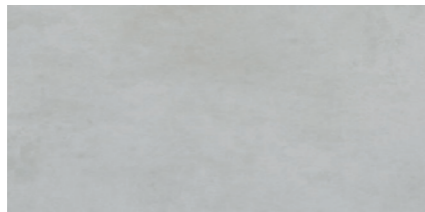

MONO

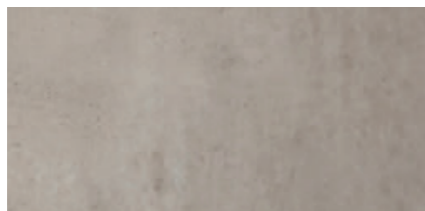

KUN



ZURI

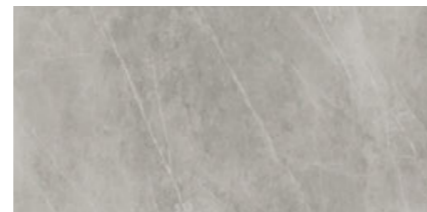

MARTIS

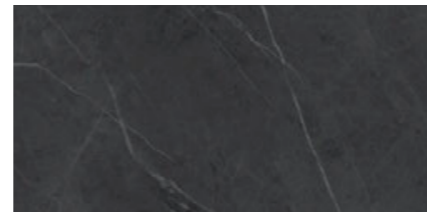

RUSK



ITA
visualizza Clap!
a casa tua



ENG
visualize Clap!
in your space

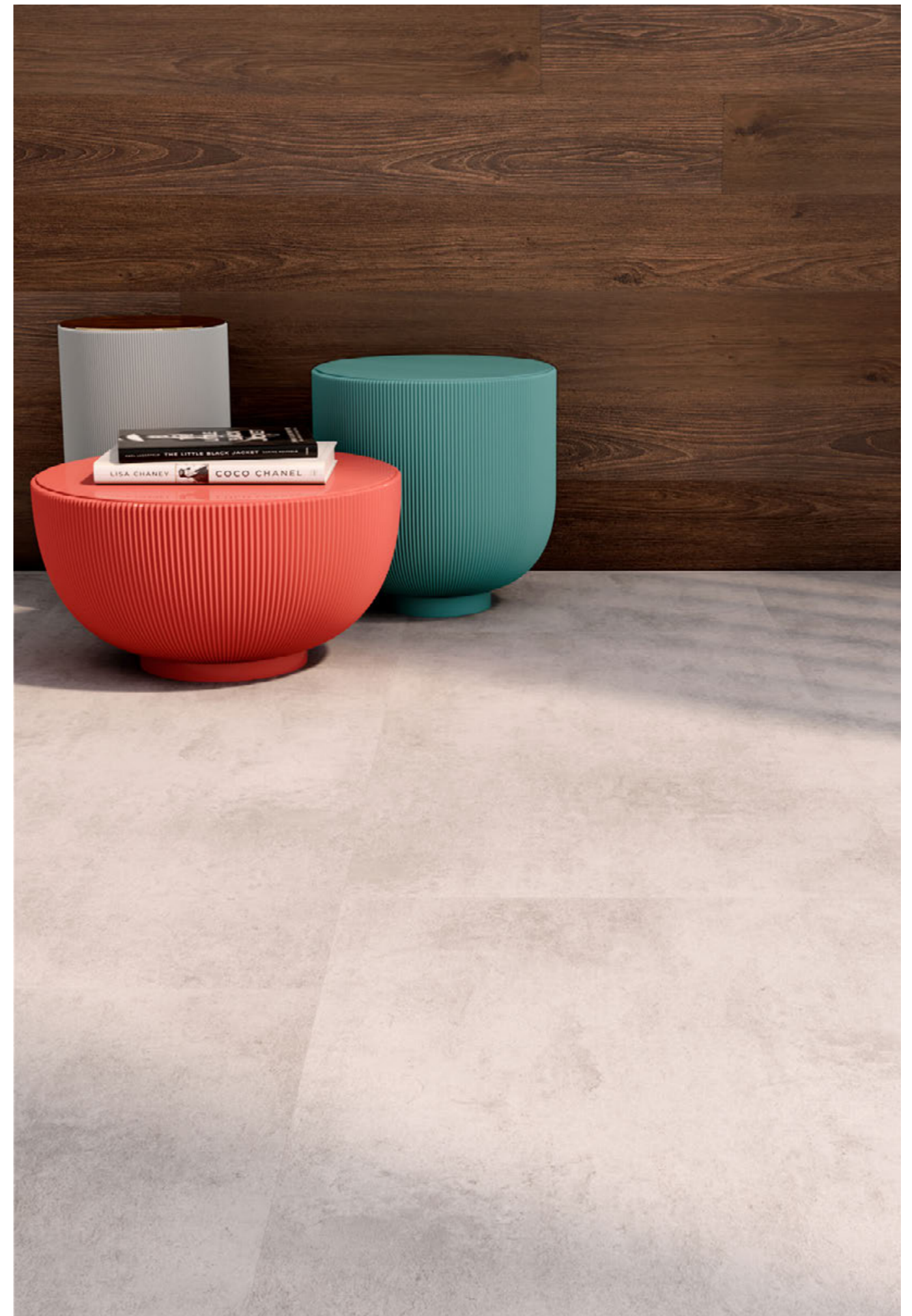

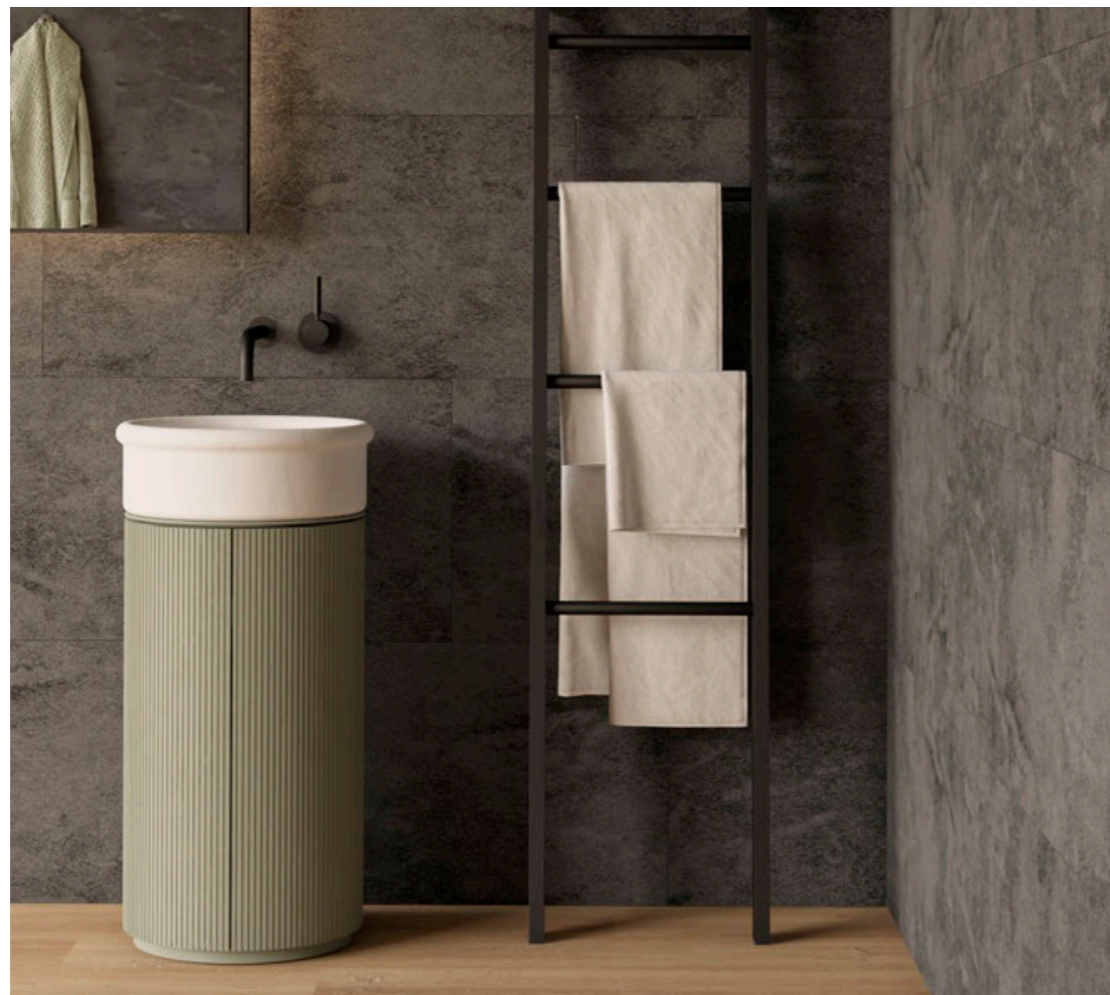

**PIETRA, MARMO E CEMENTO:
ELEGANZA E VERSATILITÀ
PER OGNI AMBIENTE
STONE, MARBLE, AND
CONCRETE: ELEGANCE AND
VERSATILITY FOR EVERY SPACE**

Perfette per chi ricerca un rivestimento capace di coniugare stile e praticità di posa, le piastrelle Clap!WALL Tiles effetto pietra, marmo e cemento, in continuità cromatica con le soluzioni a pavimento, offrono infinite possibilità creative per personalizzare ogni ambiente aggiungendo un tocco di lusso e modernità agli spazi abitativi.

Perfect for those seeking a cladding solution that combines style and ease of installation, the new stone, marble, and concrete-effect maxi-tiles can be applied both on walls and floors. They offer endless creative possibilities to personalize any environment, adding a touch of luxury and modernity to living spaces.



**POSA SEMPLIFICATA
A INCASTRO
SIMPLIFIED INTERLOCKING
INSTALLATION**

Le piastrelle effetto pietra, marmo e cemento per rivestimenti verticali rappresentano una soluzione moderna e versatile per ogni tipo di ambiente. Dotate di un sistema a incastro facilitato, queste piastrelle permettono una posa rapida e pratica tramite incollaggio, garantendo risultati impeccabili senza difficoltà. La loro formulazione innovativa, a base di pietra e polimeri, le rende particolarmente resistenti all'umidità, rendendole perfette non solo per le pareti di soggiorni, cucine e camere da letto, ma anche per gli ambienti più umidi come i box doccia.

Stone, marble, and concrete-effect tiles for vertical cladding offer a modern and versatile solution for all environments. Equipped with an easy interlocking system, these tiles enable quick and practical adhesive installation, ensuring flawless results with ease. Their innovative formulation, made of stone and polymers, provides excellent resistance to humidity, making them ideal not only for living rooms, kitchens, and bedrooms but also for moisture-prone spaces like shower enclosures.

CLAP!WALL TILES / STONE-MARBLE EFFECT

STRUTTURA, FORMATO, SOLUZIONI DI POSA /
STRUCTURE, SIZE, INSTALLATION SOLUTIONS

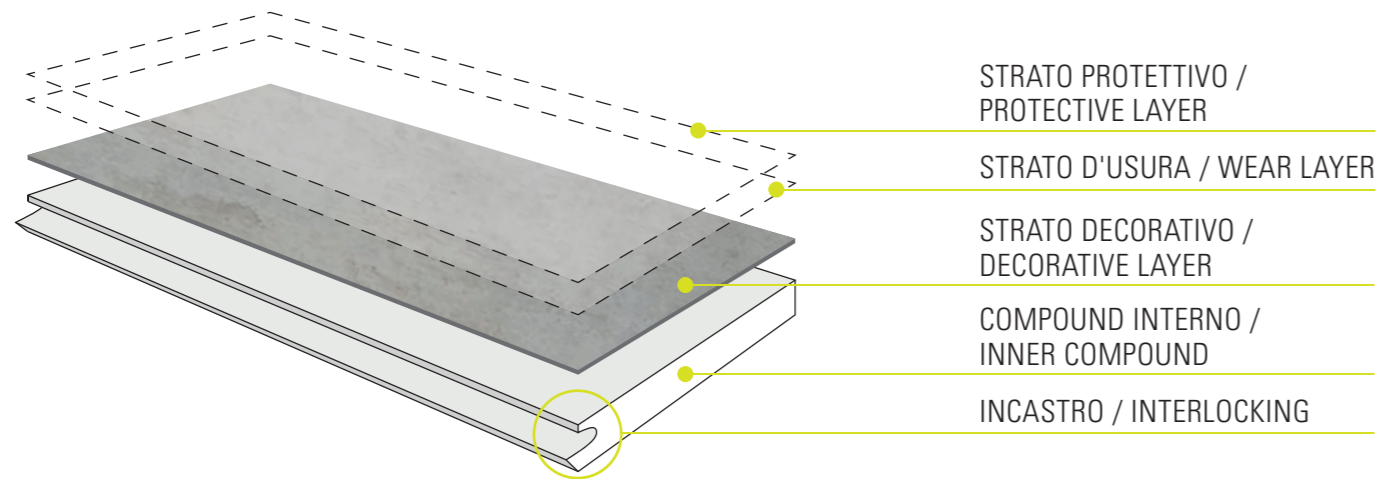

PIASTRELLA WALL / TILE WALL

5 x 465 x 940 mm



Schema libero per Tiles WALL.

Free layout for Tiles WALL.

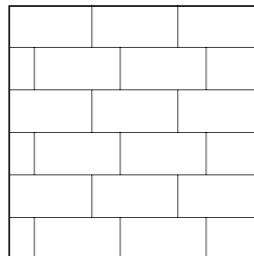

SISTEMA DI POSA A INCASTRO / INTERLOCKING INSTALLATION SYSTEM

Il nuovo tipo di incastro, ideato appositamente per facilitare l'installazione verticale delle piastrelle Tiles WALL, permette una posa precisa, rapida e semplificata.

The new type of interlocking, specially designed to facilitate the vertical installation of the Tiles TilesWALL, allows for precise, fast and simplified installation.



CLAP!WALL BOARD

WOOD EFFECT

Ispirate alle foreste più suggestive della terra, le finiture della collezione Clap!WALL coprono una vasta gamma di colorazioni offrendo tonalità effetto legno sia calde che fredde.

Inspired by the earth's most evocative forests, the Clap!WALL collection finishes cover a wide range of colours offering both warm and cool wood-effect tones.

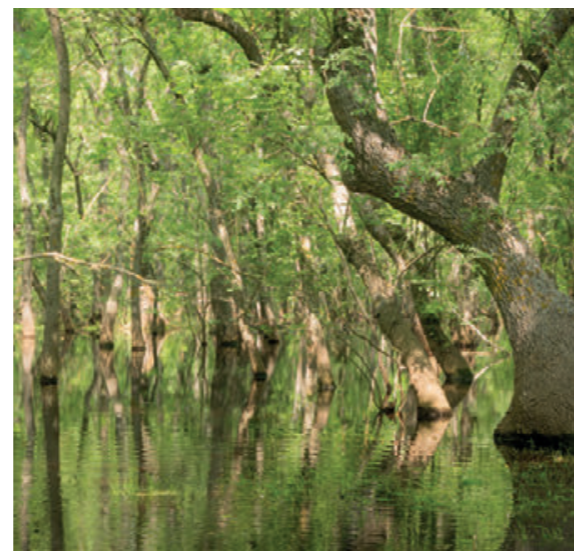

DOGA WALL / WALL BOARD

3 x 130 x 1226 mm



STANTON

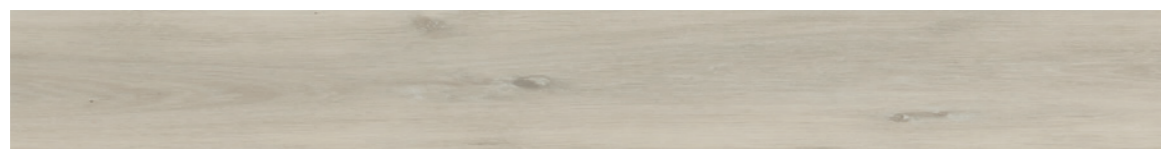

LETEA



CADDO



TSINGY



SEQUOIA



MAUI



SPINOSA



RATA

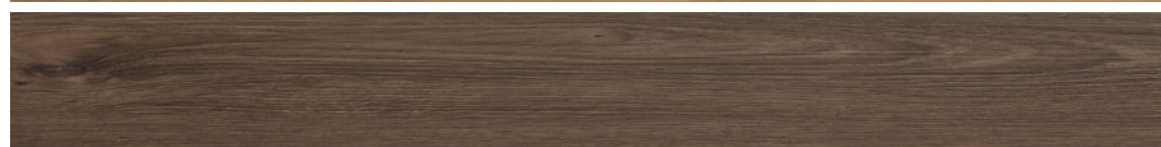

DOGHE EFFETTO LEGNO PER RIVESTIMENTI VERTICALI WOOD-EFFECT SLATS FOR VERTICAL CLADDING

Clap!WALL Board è la collezione di doghe effetto legno progettate per creare una perfetta continuità visiva con le finiture della linea Clap!GO. Realizzate in pietra e polimeri, queste doghe coniugano l'estetica naturale del legno con prestazioni tecniche superiori. La loro resistenza all'umidità le rende ideali per qualsiasi ambiente, compresi spazi esposti all'acqua come box doccia, garantendo durabilità e bellezza senza compromessi.

Clap!WALL Board is the collection of wood-effect slats designed to create perfect visual continuity with the finishes of the Clap!GO line. Made from stone and polymers, these slats combine the natural aesthetics of wood with superior technical performance. Their resistance to humidity makes them ideal for any environment, including water-exposed spaces like shower enclosures, ensuring durability and beauty without compromise.

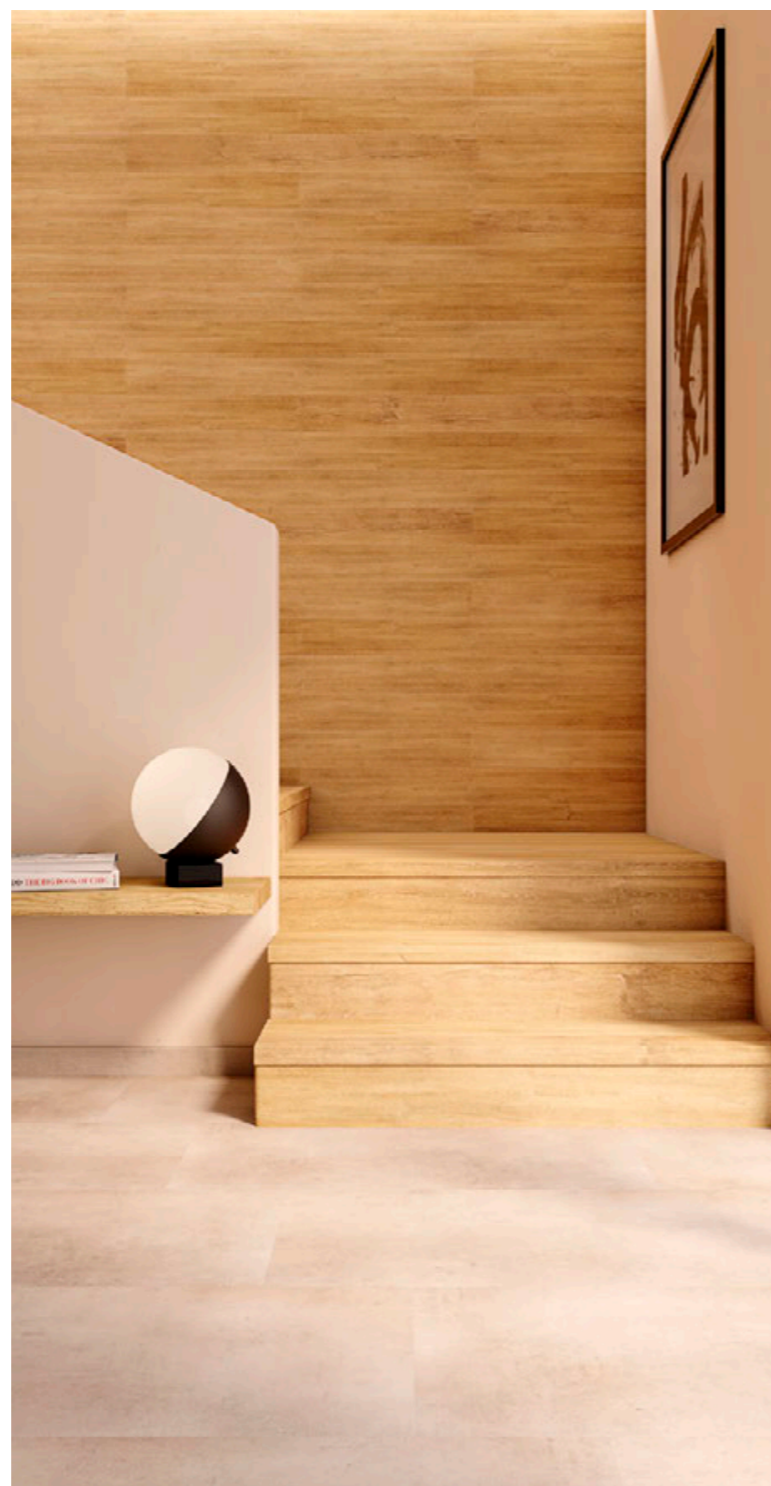

PRATICITÀ E VELOCITÀ DI POSA EASE AND SPEED OF INSTALLATION

Con uno spessore di soli 3mm, Clap!WALL Board offre un'installazione pratica e veloce, resa ancora più semplice dal sistema di incollaggio. Questa soluzione è pensata per chi desidera trasformare gli spazi con eleganza, senza rinunciare alla funzionalità. Perfette per ambienti residenziali e commerciali, le doghe Clap!WALL Board creano atmosfere calde e accoglienti, arricchendo le pareti con il fascino intramontabile del legno, in una versione innovativa e performante.

With a thickness of just 3mm, Clap!WALL Board offers practical and fast installation, made even easier by the adhesive system. This solution is designed for those who want to transform spaces with elegance without compromising functionality. Perfect for both residential and commercial environments, Clap!WALL Board slats create warm, welcoming atmospheres, enriching walls with the timeless charm of wood in an innovative and high-performance version.

CLAP!WALL BOARD

FORMATO PER PARETI / WALL FORMAT

STRUTTURA, FORMATO, SOLUZIONI DI POSA /
STRUCTURE, SIZE, INSTALLATION SOLUTIONS

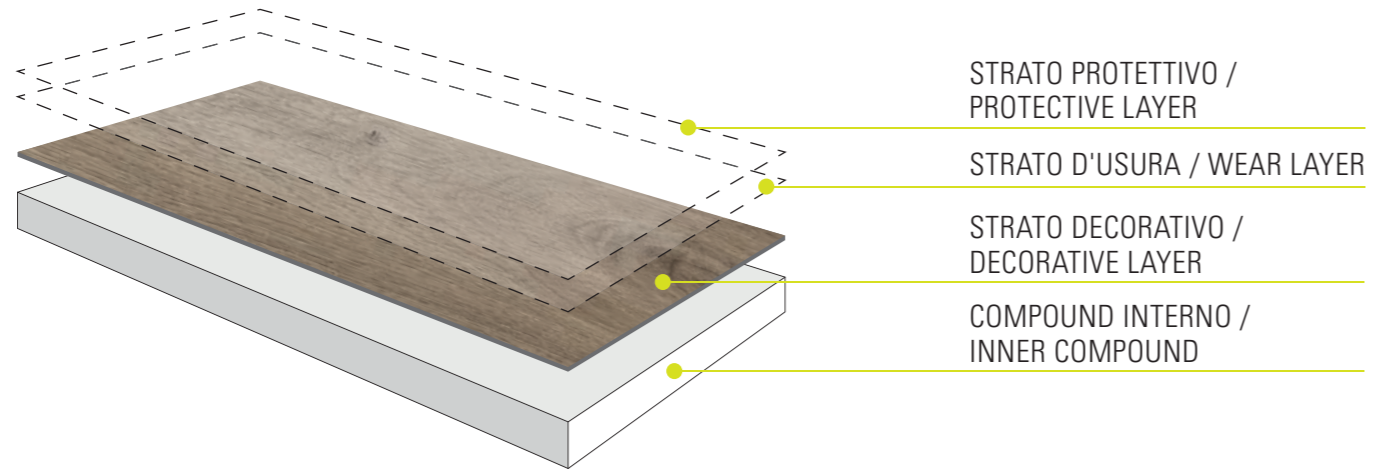

DOGA WALL / WALL BOARD

3 x 130 x 1226 mm







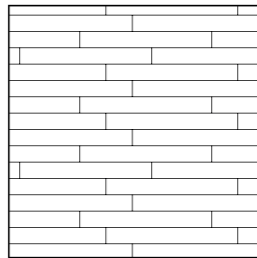



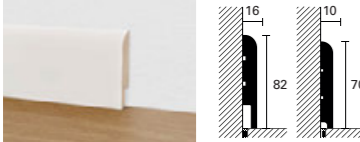

Schema libero per Doga Wall.

Free layout for Wall Board.

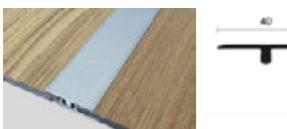

CLAP! ACCESSORI / ACCESSORIES





	NOME PRODOTTO PRODUCT NAME	DIMENSIONI (mm) SIZES (mm)	FINITURA SURFACE
BATTISCOPIA CLAP!REAL BASEBOARD CLAP!REAL			
	Battiscopa in legno - Tondo Wood baseboard - Circular	82x16x2400mm / 70x10x2400mm	bianco white
	Battiscopa in legno - Tondo Wood baseboard - Circular	70x10x2400mm	in abbinamento al pavimento matching floor color
	Battiscopa in legno - Squadrato Wood baseboard - Square	40x13x2400mm	bianco white
	Copertura per battiscopa PVC PVC skirting board cover	20x90x2500mm spessore 9mm thickness 9mm	bianco white
	Battiscopa PVC - Tondo 1 ogni 60cm PVC baseboard - Circular 1 every 60cm	70x16x2500mm	bianco white
	Clip per Battiscopa 70x16mm (opzionale) 1 ogni 60cm Baseboard Clip for 70x16mm Baseboard (optional) 1 every 60cm		bianco white
	Profilo Giunzione* Junction Profile*	lung. 2700mm length 2700mm	alluminio anodizzato anodized aluminum
	Profilo Raccordo* Connection Profile*	lung. 2700mm length 2700mm	alluminio anodizzato anodized aluminum
	Profilo di Chiusura* Closing Profile*	lung. 2700mm length 2700mm	alluminio anodizzato anodized aluminum
	Base di Incastro per Profilo di Chiusura, Raccordo, Giunzione e Gradino Joint base for closing, connection and junction profile	lung. 2700mm length 2700 mm	alluminio aluminum
	Profilo per Gradini Stairs Profile	lung. 2700mm length 2700mm	alluminio anodizzato anodized aluminum

CLAP! ACCESSORI / ACCESSORIES



	NOME PRODOTTO PRODUCT NAME	DIMENSIONI (mm) SIZES (mm)	FINITURA SURFACE
BATTISCOPIA CLAP!3D BASEBOARD CLAP!3D			
	Battiscopa in legno - Tondo Wood baseboard - Circular	82x16x2400mm / 70x10x2400mm	bianco white
	Battiscopa in legno - Squadrato Wood baseboard - Square	40x13x2400mm	bianco white
	Copertura per battiscopa PVC PVC skirting board cover	20x90x2500mm spessore 9mm thickness 9mm	bianco white
	Battiscopa PVC - Tondo 1 ogni 60cm PVC baseboard - Circular 1 every 60cm	70x16x2500mm	bianco / in abbinamento con il pavimento white / matching floor color
	Clip per Battiscopa 70x16mm (opzionale) 1 ogni 60cm Baseboard Clip for 70x16mm Baseboard (optional) 1 every 60cm		bianco white
	Profilo Giunzione* Junction Profile*	lung. 2700mm length 2700mm	alluminio anodizzato / in abbinamento con il pavimento tranne per finitura Salar anodized aluminum / matching floor color except for Salar finish
	Profilo Raccordo* Connection Profile*	lung. 2700mm length 2700mm	alluminio anodizzato / in abbinamento con il pavimento tranne per finitura Salar anodized aluminum / matching floor color except for Salar finish
	Profilo di Chiusura* Closing Profile*	lung. 2700mm length 2700mm	alluminio anodizzato / in abbinamento con il pavimento tranne per finitura Salar anodized aluminum / matching floor color except for Salar finish
	Base di Incastro per Profilo di Giunzione Joint base for junction profile	lung. 2700mm length 2700 mm	verde green
	Base di Incastro per Profilo di Chiusura e Raccordo Joint base for closing and connection	lung. 2700mm length 2700 mm	verde green

* Da abbinare con base ad incastro da compensarsi a parte.
To be combined with an interlocking base to be compensated separately.

CLAP! ACCESSORI / ACCESSORIES

	NOME PRODOTTO PRODUCT NAME	DIMENSIONI (mm) SIZES (mm)	FINITURA SURFACE
	Profilo per Gradini Stairs Profile	lung. 2700mm length 2700mm	alluminio anodizzato anodized aluminum
	Clap!3D Step - Incastro 5G Compatibile solo con Doga Max Clap!3D Step - 5G interlocking Compatible with only Max Board	170x40x15 mm lung. 1800 mm length 1800 mm	decoro legno wood decor
	Clap!3D Edge - Incastro 5G Compatibile solo con Doga Max Clap!3D Edge - 5G interlocking Compatible with only Max Board	105x200 mm lung. 1800 mm length 1800 mm	decoro legno wood decor
	Pistola termica per profilo Edge Edge profile heat gun		

BATTISCOPA CLAP!GO BASEBOARD CLAP!GO





	Battiscopa in legno - Tondo Wood baseboard - Circular	82x16x2400mm / 70x10x2400mm	bianco white
	Battiscopa in legno - Squadrato Wood baseboard - Square	40x13x2400mm	bianco white
	Copertura per battiscopa PVC PVC skirting board cover	20x90x2500mm spessore 9mm thickness 9mm	bianco white
	Battiscopa PVC - Tondo PVC baseboard - Circular	70x16x2200mm	bianco / in abbinamento con il pavimento (SIA PER DOGA FLOOR CHE TILES) white / matching floor color (FOR FLOOR AND TILES BOARD)
	Battiscopa PVC - Squadrato PVC baseboard - Square	45x10x2500mm	bianco / (SOLO PER DOGA FLOOR) white (ONLY FOR FLOOR BOARD)

CLAP! ACCESSORI / ACCESSORIES



	NOME PRODOTTO PRODUCT NAME	DIMENSIONI (mm) SIZES (mm)	FINITURA SURFACE
	Battiscopa PVC - Tondo PVC baseboard - Circular	70x10x2200mm	bianco / in abbinamento con il pavimento (SOLO PER DOGA FLOOR) white / matching floor color (ONLY FOR FLOOR BOARD)
	Clip per Battiscopa 70x16mm (opzionale) 1 ogni 60cm Baseboard Clip for 70x16mm Baseboard (optional) 1 every 60cm		bianco white
	Battiscopa PVC - Squadrato PVC baseboard - Square	45x10x2500mm	bianco / (SOLO PER DOGA FLOOR) white (ONLY FOR FLOOR BOARD)
	Profilo Giunzione* Junction Profile*	lung. 2700mm length 2700mm	alluminio anodizzato / in abbinamento con il pavimento anodized aluminum / matching floor color
	Profilo Raccordo* Connection Profile*	lung. 2700mm length 2700mm	alluminio anodizzato / in abbinamento con il pavimento anodized aluminum / matching floor color
	Profilo di Chiusura* Closing Profile*	lung. 2700mm length 2700mm	alluminio anodizzato / in abbinamento con il pavimento anodized aluminum / matching floor color
	Base di Incastro per Profilo Giunzione per doghe di spessore 5mm Joint base for junction profile for 5mm thickness board	lung. 2700mm length 2700mm	verde green
	Base di Incastro per Profilo di Chiusura e Raccordo, per doghe di spessore 5mm Joint base for closing and connection profile for 5mm thickness board	lung. 2700mm length 2700mm	verde green
	Base di Incastro per Profilo Giunzione per tiles di spessore 7mm Joint base for junction profile for 7mm thickness board	lung. 2700mm length 2700mm	verde green
	Base di Incastro per Profilo di Chiusura e Raccordo per tiles di spessore 7mm Joint base for closing and connection profile for 7mm thickness board	lung. 2700mm length 2700mm	verde green
	Profilo per Gradini Stairs Profile	lung. 2700mm length 2700mm	alluminio anodizzato anodized aluminum

* Da abbinare con base ad incastro da compensarsi a parte.
To be combined with an interlocking base to be compensated separately.

CLAP! ACCESSORI / ACCESSORIES













	NOME PRODOTTO PRODUCT NAME	DIMENSIONI (mm) SIZES (mm)	FINITURA SURFACE
	Clap!GO Step Floor - Incastro Smart <i>Clap!GO Step Floor - Smart Locking</i>	120x40x13,50 mm lungh. 1800 mm length 1800 mm	decoro legno <i>wood decor</i>
	Clap!GO Step Tiles - Incastro 5G <i>Clap!GO Step Tiles - 5G interlocking</i>	320x40x15 mm lungh. 1800 mm length 1800 mm	decoro pietra <i>stone decor</i>
	Clap!GO Edge* Floor - Incastro Smart <i>Clap!GO Edge* Floor - smart locking</i>	120x185x1800 mm lungh. 1800 mm length 1800 mm	decoro legno <i>wood decor</i>
	Clap!GO Edge Tiles - Incastro 5G <i>Clap!GO Edge Tiles - 5G interlocking</i>	105x200 mm lungh. 1800 mm length 1800 mm	Decoro pietra <i>Stone decor</i>
	Pistola termica per profilo Edge <i>Edge profile heat gun</i>		

ACCESSORI CLAP!WALL ACCESSORIES CLAP!WALL

	Profilo di chiusura e per angoli esterni Arrotondato <i>Closing profile and for rounded external corners</i>	lungh. 2700mm length 2700mm	alluminio anodizzato <i>anodized aluminum</i>
	Profilo di chiusura e per angoli esterni Squadrato <i>Closing and outer corner profile squared</i>	lungh. 2700mm length 2700mm	alluminio anodizzato <i>anodized aluminum</i>
	Profilo di chiusura e per angoli esterni Sottile <i>Closing and outer corner profile thin</i>	lungh. 2700mm length 2700mm	alluminio anodizzato <i>anodized aluminum</i>

* profilo fornito planare, da sagomare con apposita pistola termica.
profile supplied planar, to be shaped with special heat gun

CLAP! EXTRA

	NOME PRODOTTO PRODUCT NAME	DIMENSIONI (mm) SIZES (mm)	RESA YIELD
	Rasafuga perfetto* Riempitivo per la rasatura delle fughe <i>Filler for levelling joints</i>	10kg	0,2/0,5 kg/m ²
	Chimigrip* Promotore di adesione acrilico all'acqua per la preparazione del sottofondo da rasare <i>Water-based acrylic adhesion promoter for preparing the substrate to be shaved</i>	5 l	100/200 kg/m ²
	Rasochim 1400M* Lisciatura cementizia tixotropica a rapido indurimento per pavimenti e pareti con spessori fino a 6mm <i>Quick-hardening thixotropic cement-based smoothing compound for floor and wall thicknesses up to 6 mm</i>	25kg	1,8 kg/m ² per 1 mm spessore <i>for 1mm thickness</i>
	Rasochim AL* Autolivellante cementizio a rapido indurimento per pavimentazioni civili con spessori fino a 10mm <i>Quick-hardening cement-based self-levelling compound for civil flooring up to 10 mm thick</i>	25kg	1,5 kg/m ² per 1 mm spessore <i>for 1mm thickness</i>
	Parket Kit* Sigillante acrilico colorato sovraverniciabile <i>Overpaintable coloured acrylic sealant</i>	310 ml	12ml per fughe 5x5mm 3ml per fughe 10x10mm <i>12ml for 5x5mm gap 3ml for 10x10mm gap</i>
	colori / colors:		
			
	bianco grigio noce wenge rovere iroko ciliegio <i>white grey walnut wenge oak iroko cherry wood</i>		
	Barriera al vapore* <i>Vapour barrier*</i>	99m ² per rotolo <i>99m² per roll</i>	-
	Detergente Antistatico Intensivo Clap! Cleaner <i>Antistatic Intensive Clap! Cleaner</i>	1 l	-
	Detergente Antistatico Intensivo Clap! Cleaner <i>Antistatic Intensive Clap! Cleaner</i>	5 l	-
	Colla Bicomponente per Clap! Wall <i>Bicomponent Glue for Clap! Wall</i>	10 kg comp.A + 1kg comp.B	0,3-0,8 Kg/m ²
	Colla monocomponente per Clap! <i>Monocomponent Glue for Clap!</i>	10 kg in secchio <i>in bucket</i>	300-450 g/m ²
	Colla monocomponente per Clap! <i>Monocomponent Glue for Clap!</i>	2pz 5k cad in salsicciotti <i>in sausages</i>	300-450 g/m ²

* Articoli opzionali per la preparazione del sottofondo.
Optional items for substrate preparation.

AREA TECNICA

TECHNICAL AREA

SCHEDE TECNICHE E ISTRUZIONI DI POSA
TECHNICAL FEATURES AND INSTALLATION GUIDELINES



ITA

www.decodecking.it/it/area-tecnica/
scannerizza il QR code.



ENG

www.decodecking.it/en/technical-area/
scan the QR code.

PROVA IL VISUALIZER E VISUALIZZA CASA TUA
TRY THE VISUALIZER AND VISUALIZE YOUR SPACE



ITA

www.decodecking.it/it/visualizer/
scannerizza il QR code.



ENG

www.decodecking.it/en/visualizer/
scan the QR code.



Déco S.p.A.

Via Provinciale 2763
24059 Urgnano (BG) Italia
T/F +39 035 526209
info@decodecking.it
www.decodecking.it

Credits

Graphic design - studioPANG
Printing - InteseGrafiche



